

# SLB-0113 | Installation Manual

## Universal Flat Mount Bracket kit

Thank you for purchasing Solarland<sup>®</sup> products. SLB-0113 mounting kits are used for 45W-100W Solarland<sup>®</sup> panels at an tilt angle from 0°--- 90°

### Components And Parts

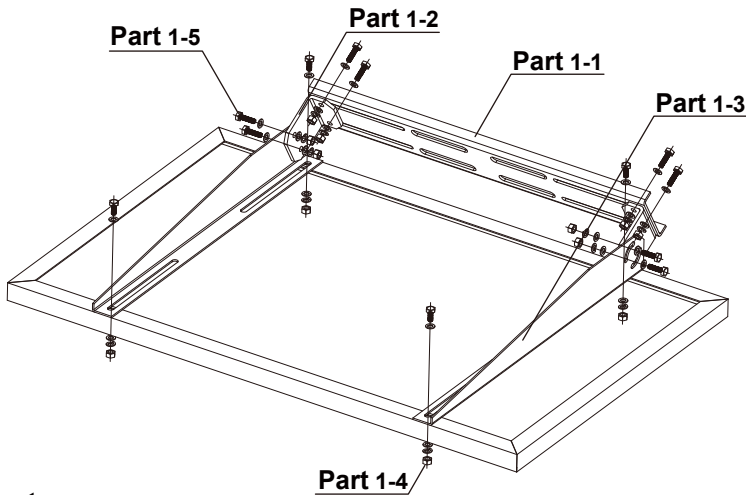

### Part

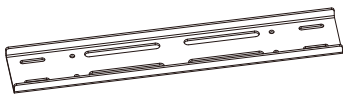

#### Part 1-1

Component	Fixed Bracket
Material	5052Al
Quantity	1

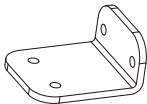

#### Part 1-2

Component	Strutting Piece
Material	5052Al
Quantity	2

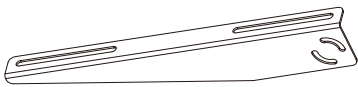

#### Part 1-3

Component	Tilt Arm
Material	5052Al
Quantity	2

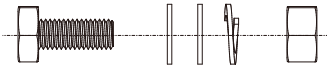

#### Part 1-4-1

Component	Mounting Bolt(M8×20)
Material	AISI304
Quantity	4



#### Part 1-4-2

Component	Mounting Bolt(M6×20)
Material	AISI304
Quantity	4



#### Part 1-5

Component	Mounting Bolt(M8×20)
Material	AISI304
Quantity	8

**Step1.** Attach the PV module to the mounting bracket using the nuts, bolts, washers, and lock washers provided. See **figure 1**. Caution: If additional holes on the frame of the PV module are needed, great care must be used when drilling. Damage to the module can easily occur rendering it useless. You may find it helpful to lubricate the nut and bolt to facilitate easy removal at a later date.

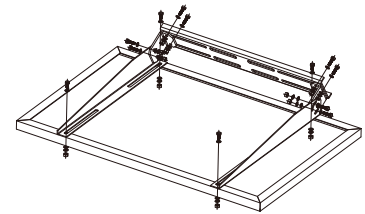

figure 1

**Step2.** To adjust the tilt angle of the PV panel, change the location of M8 bolts in the arc hole of the tilt arms. Remember to use lock washers to prevent vibration from working them loose.

**Step3.** Place PV module and mount assembly on mounting surface in the exact place to be installed. See **figure 2**. Use at least 4 fastening points. Use four M8 bolts, washers, lock washers and nuts if possible. Otherwise use wood screws, sheet metal screws, anchors, or molly bolts ( not included ).

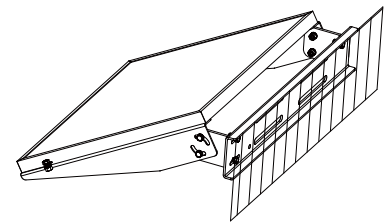

figure 2

**Step4.** Be sure to seal all roof or wall penetrations with a compatible weatherproof sealant.

#### Note

Pole Mounting can be accomplished using two U-bolts (not included). See **figure 3**.

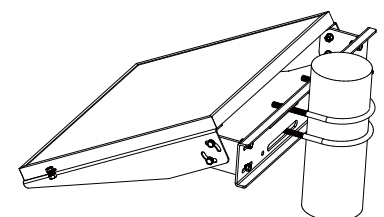

figure 3