

Smart choice for power™

xantrex™

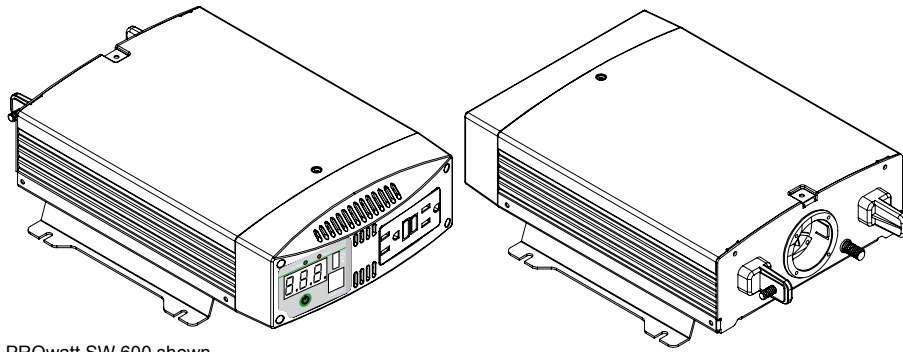

PROwatt SW 600 shown.

Owner's Guide

***PROwatt™ SW* Sine Wave Inverter**

PROwatt SW 600
PROwatt SW 1000
PROwatt SW 2000

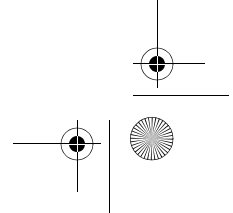
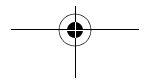
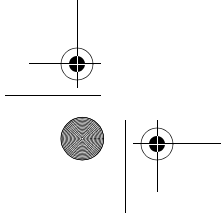
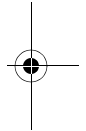
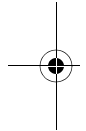
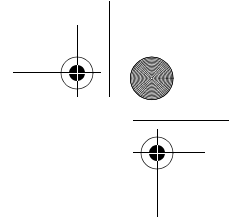
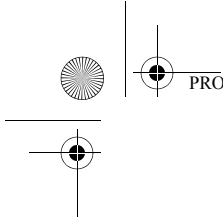

Trademarks

Xantrex, **PROwatt**, and **Smart choice for power** are trademarks of Schneider Electric Services International sprl, registered in the U.S. and other countries. Other trademarks, registered trademarks, and product names are the property of their respective owners and are used herein for identification purposes only.

Notice of Copyright

Xantrex PROwatt™ SW Sine Wave Inverter Owner's Guide © September 2010 Xantrex Technology USA Inc. All rights reserved. No part of this document may be reproduced in any form or disclosed to third parties without the express written consent of: Xantrex Technology USA Inc., 541 Roske Drive, Suite A, Elkhart, Indiana, USA. Xantrex Technology USA Inc. reserves the right to revise this document and to periodically make changes to the content hereof without obligation or organization of such revisions or changes unless required to do so by prior arrangement.

Exclusion for Documentation

UNLESS SPECIFICALLY AGREED TO IN WRITING, XANTREX TECHNOLOGY USA INC. ("XANTREX")

(A) MAKES NO WARRANTY AS TO THE ACCURACY, SUFFICIENCY OR SUITABILITY OF ANY TECHNICAL OR OTHER INFORMATION PROVIDED IN ITS MANUALS OR OTHER DOCUMENTATION;

(B) ASSUMES NO RESPONSIBILITY OR LIABILITY FOR LOSSES, DAMAGES, COSTS OR EXPENSES, WHETHER SPECIAL, DIRECT, INDIRECT, CONSEQUENTIAL OR INCIDENTAL, WHICH MIGHT ARISE OUT OF THE USE OF SUCH INFORMATION. THE USE OF ANY SUCH INFORMATION WILL BE ENTIRELY AT THE USER'S RISK; AND

(C) REMINDS YOU THAT IF THIS MANUAL IS IN ANY LANGUAGE OTHER THAN ENGLISH, ALTHOUGH STEPS HAVE BEEN TAKEN TO MAINTAIN THE ACCURACY OF THE TRANSLATION, THE ACCURACY CANNOT BE GUARANTEED. APPROVED XANTREX CONTENT IS CONTAINED WITH THE ENGLISH LANGUAGE VERSION WHICH IS POSTED AT WWW.XANTREX.COM.

Date and Revision

September 2010 Rev C

Document Part Number

975-0529-01-01

Product Numbers

PROwatt SW 600: 806-1206
PROwatt SW 1000: 806-1210
PROwatt SW 2000: 806-1220

Contact Information

Telephone: 1 800 670 0707 (toll free North America)
Fax: 1 800 994 7828 (toll free North America)
Email: customerservice@xantrex.com
Web: www.xantrex.com

About This Guide

Purpose

The purpose of this Owner's Guide is to provide explanations and procedures for operating, installing, maintaining, and troubleshooting the PROwatt™ SW Sine Wave Inverter.

Scope

The Guide provides safety guidelines, as well as information about operating, installing, and troubleshooting the inverter. It does not provide details about particular brands of batteries. You need to consult individual battery manufacturers for this information.

Xantrex recommends that installation should be handled by qualified installers including licensed technicians and electricians. Qualified installers have knowledge and experience in installing electrical equipment, knowledge of the applicable installation codes, and awareness of the hazards involved in performing electrical work and how to reduce those hazards.

Audience

The Guide is intended for users and operators of the PROwatt™ SW Sine Wave Inverter.

Conventions Used

The following conventions are used in this guide.

DANGER

STATEMENT OF HAZARD

Contains statements of avoidance or strict compliance.

Failure to follow these instructions will result in death or serious injury.

WARNING

STATEMENT OF HAZARD

Contains statements of avoidance or strict compliance.

Failure to follow these instructions can result in death or serious injury.

CAUTION

STATEMENT OF HAZARD

Contains statements of avoidance or strict compliance.

Failure to follow these instructions can result in minor or moderate injury.

CAUTION

STATEMENT OF HAZARD

Contains statements of avoidance or strict compliance.

Failure to follow these instructions can damage the unit and/or damage other equipment.

IMPORTANT: These notes describe things which are important for you to know, however, they are not as serious as a danger, warning, or caution.

Related Information

You can find more information about Xantrex Technology USA Inc. as well as its products and services at www.xantrex.com.



The product marking on the left when found imprinted on electrical and electronic units and appliances means that you are to refer to this guide for cautions and warnings.

Important Safety Instructions

IMPORTANT: READ AND SAVE THIS OWNER'S GUIDE FOR FUTURE REFERENCE.

This chapter contains important safety instructions for the PROwatt™ SW Sine Wave Inverter.

Before using the PROwatt™ SW Sine Wave Inverter, READ ALL instructions and cautionary markings on or provided with the PROwatt™ SW Sine Wave Inverter, the batteries, and all appropriate sections of this guide.

DANGER

ELECTRICAL SHOCK HAZARD

- Do not expose the PROwatt SW Inverter to rain, snow, spray, or bilge water.
- Do not operate the inverter if it has received a sharp blow, been dropped, has cracks or openings in the enclosure including if the fuse cover has been lost, damaged, or will not close, or otherwise damaged in any other way.
- Do not disassemble the inverter. Internal capacitors remain charged after all power is disconnected.
- Disconnect DC power from the inverter before attempting any maintenance or cleaning or working on any circuits connected to the battery charger. See note below.
- Do not operate the inverter with damaged or substandard wiring. Make sure that all wiring is in good condition and is not undersized.

Failure to follow these instructions will result in death or serious injury.

NOTE: Turning off the inverter using the power switch button will not reduce an electrical shock hazard.

Precautions When Working With Batteries

WARNING

BURN FROM HIGH SHORT-CIRCUIT CURRENT, FIRE AND EXPLOSION FROM VENTED GASES HAZARDS

- Always wear proper, non-absorbent gloves, complete eye protection, and clothing protection. Avoid touching your eyes and wiping your forehead while working near batteries. See note #4.
- Remove all personal metal items, like rings, bracelets, and watches when working with batteries. See notes #5 and #6.
- Never smoke or allow a spark or flame near the engine or batteries.
- Do not operate the the inverter in compartments containing batteries or flammable materials, or in locations that require ignition-protected equipment. See note #8.

Failure to follow these instructions can result in death or serious injury.

NOTES:

1. Locate the PROwatt™ SW Sine Wave Inverter unit away from batteries in a well ventilated compartment.
2. Always have someone within range of your voice or close enough to come to your aid when you work near a lead-acid battery.
3. Always have plenty of fresh water and soap nearby in case battery acid contacts skin, clothing, or eyes.
4. If battery acid contacts skin or clothing, wash immediately with soap and water. If acid enters your eye, immediately flood it with running cold water for at least twenty minutes and get medical attention immediately.
5. Use extra caution to reduce the risk of dropping a metal tool on the battery. It could spark or short circuit the battery or other electrical parts and could cause an explosion.
6. Batteries can produce a short circuit current high enough to weld a ring or metal bracelet or the like to the battery terminal, causing a severe burn.
7. When removing a battery, always remove the negative terminal from the battery first for systems with grounded negative. If it is grounded positive, remove the positive terminal first. Make sure all loads connected to the battery and all accessories are off so you don't cause an arc.
8. This inverter contains components which tend to produce arcs or sparks. Other locations that require ignition-protected equipment include any space containing gasoline-powered machinery, fuel tanks, as well as joints, fittings, or other connections between components of the fuel system.

FCC Statement



WARNING

This device complies with Part 15 of the FCC rules. Operation is subject to the following two conditions:
(1) This device may not cause harmful interference and
(2) this device must accept any interference received, including interference that might cause undesired operation.

NOTE: This equipment has been tested and found to comply with the limits for a Class A digital device, pursuant to part 15 of the FCC Rules. These limits are designed to provide reasonable protection against harmful interference when the equipment is operated in a commercial environment. This equipment generates, uses, and can radiate radio frequency energy and, if not installed and used in accordance with the instruction manual, may cause harmful interference to radio communications. Operation of this equipment in a residential area is likely to cause harmful interference in which case the user will be required to correct the interference at his own expense.

Contents

Important Safety Instructions	iii
Introduction	1
Features	3
Installation	6
Operation	15
Troubleshooting	19
Specifications	21
Warranty and Return Information	22

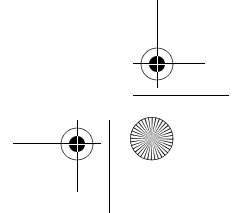
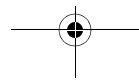
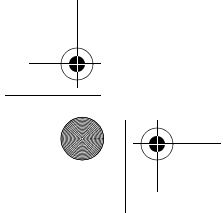
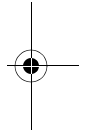
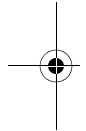
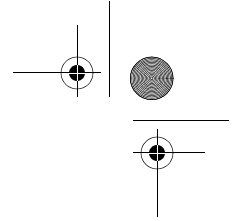
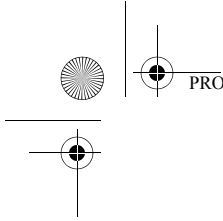

Introduction

Thank you for purchasing the PROwatt™ SW Sine Wave Inverter. The PROwatt SW Inverter is a high quality, true sine wave output inverter. It is designed to operate AC loads as if these loads were operating from grid/utility supplied power in household AC outlets. To get the most out of your PROwatt™ SW Sine Wave Inverter, carefully read and follow the instructions in this guide.

PROwatt SW Inverter Series

There are three PROwatt SW Inverter models in the series namely:

- PROwatt SW 600,
- PROwatt SW 1000, and
- PROwatt SW 2000.

This Guide contains information about all three models. Unless specified by the model name, all features, functions, and instructions will pertain to all models. All the models of the inverter will be referred to collectively as PROwatt SW Inverter.

Quality Power

The PROwatt SW Inverter is a professional-quality, mid-range inverter designed to handle a variety of applications including compact microwaves, TVs, VCRs, coffee makers, and small power tools.

- The PROwatt SW Inverter provides optimal continuous power, making it ideal for large single loads, intermittent loads, or multiple smaller loads.
- The inverter's high surge capability lets you handle many hard-to-start loads, including large TVs, refrigerators, and freezers.

Model	Continuous	Surge Power
PROwatt SW 600	540 watts	1200 watts
PROwatt SW 1000	900 watts	2000 watts
PROwatt SW 2000	1800 watts	3000 watts

- The unit's low standby battery demand means you don't have to worry about excessive drain on your battery if you leave the inverter on for a few days. When the inverter is on but no power is being supplied to a load, the inverter draws less than 800 mA from the battery.

Introduction

Ease of Use

Superior features and rugged durability have been combined with ease of use:

- The unit is compact, light weight, and easy to install.
- You can power loads directly from the dual GFCI-protected AC receptacles on the front panel.
- Easy-to-read digital display on the front panel lets you monitor system performance at a glance.
- The optional PROwatt Remote Panel lets you control the inverter from a convenient location—up to 25 feet (7.6 m) away—while the inverter itself is mounted out of sight and close to the batteries.
- A convenient USB port powers most modern electronic products.

Comprehensive Protection

The PROwatt SW Inverter is equipped with the following protection features:

GFCI protection	De-energizes the AC circuits and thereby protects the user from electric shock if a ground fault occurs.
Low battery voltage alarm	Alerts you if the battery has become discharged to 11 V or lower.

Low battery voltage shutdown	Automatically shuts the inverter down if the battery voltage drops below 10.5 V. This feature protects the battery from being completely discharged. Within five minutes after shutdown, the unit recovers automatically once the battery voltage reaches above 11.5 Vdc. After five minutes, the unit turns itself off.
High battery voltage shutdown	Shuts the inverter down automatically if the input voltage rises to more than 15.5 V. Within five minutes after shutdown, the unit recovers automatically once the battery voltage falls below 15.5 Vdc. After five minutes, the unit turns itself off.
AC output overload shutdown	Shuts the unit down automatically if a short circuit occurs or if the loads attached to the inverter exceed the operating limits.
Over temperature shutdown	Turns the inverter off if its temperature rises above an acceptable level. Within five minutes after shutdown, the unit recovers automatically once the temperature of the unit cools down. After five minutes of operating in high temperature, the unit turns itself off.

Features

The following information describes the main features of the PROwatt SW Inverter. We recommend that you familiarize yourself with these features before installing and operating the unit.

Materials List

Your PROwatt SW Inverter package includes these items:

- PROwatt SW Inverter unit,
- Owner's Guide.

If any of these materials are missing or are unsatisfactory in any way, please contact Customer Service (see "Contact Information" on page i of this guide).

Optional Accessory

The PROwatt SW Inverter can also be installed with the PROwatt Remote Panel that comes with a 25-foot (7.6 m) communications cable (part number 808-9001).

In marine applications, Xantrex recommends the use of additional drip protection such as drip shields (part number 808-1050). See notes on page 8.

For ordering information, please contact Customer Service (see "Contact Information" on page i of this guide). Please reference the part number above when ordering.

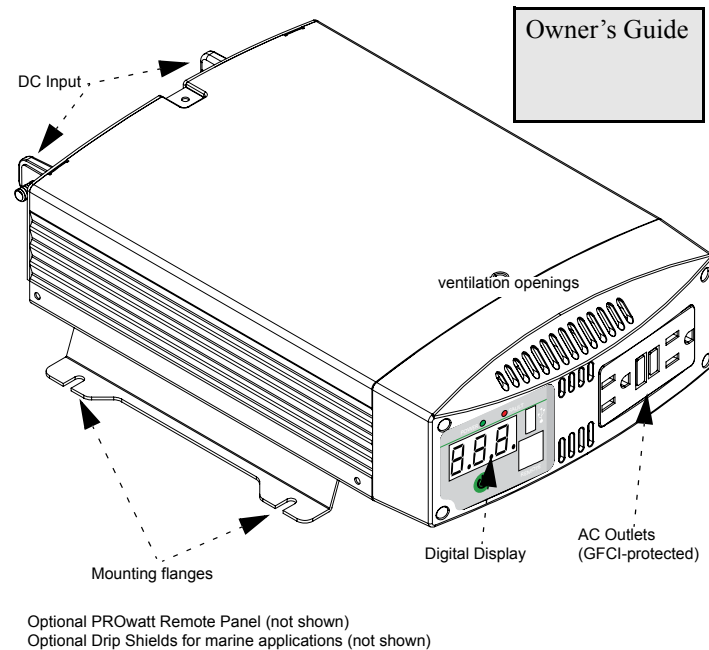

Figure 1 PROwatt SW Inverter (PROwatt SW 600 shown)

Features

Front Panel Details

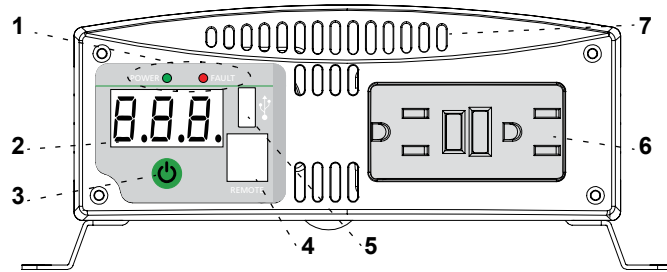

Figure 2 PROwatt SW Inverter Front Panel (PROwatt SW 600 shown)

Feature	Description
3	Power Switch Button Turns the inverter ON or OFF.
4	Remote Switch Port Use to connect the optional PROwatt Remote Panel via a communications cable.
5	USB Port Powers and charges USB-enabled devices.
6	GFCI-protected AC Outlets Equipped with two AC outlets that are protected by a standard Ground Fault Circuit Interruptor (GFCI) device with reset and test buttons.
7	Ventilation Holes Allows internal heat to escape.

Feature	Description
1	Indicator LEDs Green LED indicates that the unit is on and receiving power. When a shutdown occurs due to an error condition the Green LED remains on. Red LED indicates an error or alarm condition.
2	Digital Display Shows input voltage (in volts), output power (in kilowatts), and error code information.

Back Panel Details

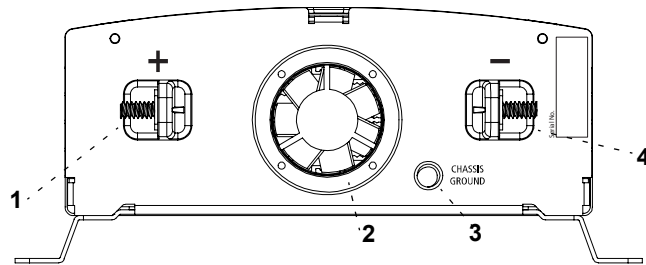

Figure 3 PROwatt SW Inverter Back Panel (PROwatt SW 600 shown)

Feature	Description
3	Chassis Ground (GND) Terminal
4	Negative (-) DC Terminal Accepts lug or ring connectors appropriate to the cable size being used. See Table 1 : Voltage Drop Per Foot of DC Cable on page 10 for recommendations.

Feature	Description
1	Positive (+) DC Terminal Accepts lug or ring connectors appropriate to the cable size being used. See Table 1 : Voltage Drop Per Foot of DC Cable on page 10 for recommendations.
2	Cooling Fan Automatically turns on when internal temperature reaches more than 122 °F (50 °C). It turns off when the internal temperature falls below 122 °F (50 °C).

Installation

Guidelines

Follow all instructions from this guide and instructions including safety guidelines from the battery manufacturer. Installing battery cables require some electrical knowledge and local electrical codes.

CAUTION

IMPROPER INSTALLATION BY AN UNQUALIFIED INSTALLER

If you do not have some electrical knowledge and knowledge of local electrical codes or are not comfortable installing cables yourself, use a qualified installer including a licensed technician and electrician. Qualified installers have knowledge and experience in installing electrical equipment, knowledge of the applicable installation codes, and awareness of the hazards involved in performing electrical work and how to reduce those hazards.

Failure to follow these instructions can damage the unit and/or damage other equipment.

Tools and Materials

- Adjustable wrench for fastening DC terminal bolts,
- Two battery cables (copper, appropriately sized according to application) with connectors already crimped by the company or store where you purchased the cables,
- Ground cable (copper, appropriately sized) for attaching to the ground chassis,
- DC-rated fuses (and fuse holders),
- Screwdriver (flathead and Philips), power screwdriver, or power drill for use in mounting the inverter,
- Mounting screws (4) size #10.

Basic Installation Steps

1. Determine battery capacity.
2. Determine a charging system.
3. Choose a location.
4. Mount the inverter.
5. Connect the chassis ground.
6. Connect the battery cables.

Determine Battery Capacity

Battery type and battery size strongly affect the performance of the PROwatt SW Inverter. Therefore, you need to identify the type of loads your inverter will be powering and how much you will be using them between charges. Once you know how much power you will be using, you can determine how much battery capacity you need. Xantrex recommends that you purchase as much battery capacity as possible.

CAUTION

RISK OF INVERTER DAMAGE

Connect only to a battery that has a nominal output of 12 volts. Do not connect to 6-volt or 24-volt battery systems.

Failure to follow these instructions can damage the unit and/or damage other equipment.

Determine A Charging System

The charging system must be appropriate for your particular installation. A well-designed charging system will ensure that power is available when you need it and that your batteries remain in top condition. Inadequate charging will degrade system performance and the wrong type of charger will reduce battery life. For a list of Xantrex Battery Chargers, go to www.xantrex.com or contact Customer Service (see “Contact Information” on page i of this guide).

Choose A Location

Install the PROwatt SW Inverter in a location that meets the following requirements:

Dry	Do not allow water or other liquids to drop or splash on the inverter.
Cool	Ambient air temperature should be between 32 °F and 104 ° F (0 °C and 40 ° C)—the cooler the better within this range.
Ventilated	Allow at least 2 inches (5 cm) of clearance around the inverter for air flow. Ensure that ventilation openings on the DC end and the bottom of the unit are not obstructed.

Installation

Safe	Do not install the inverter in the same compartment as batteries or in any compartment capable of storing flammable liquids like gasoline.
Close to battery	Do not use excessive DC cable lengths: they increase wire resistance and reduce input power.
Protected from battery gases	Do not mount the inverter where it will be exposed to gases produced by the batteries. These gases are very corrosive and prolonged exposure will damage the inverter.

NOTES:

When planning to install the PROwatt SW Inverter, be sure that you consider the location and orientation carefully.

The inverter may be used in marine applications such as inside boat compartments that are always dry and protected from prolonged and sustained exposure to moisture and water. Even with the installation of additional drip protection such as drip shields¹, this will not prevent the entry of dripping water when the inverter is installed in outside areas of boats such as on the promenade or on the main and weather decks.

¹. Drip shields order part number 808-1050.

Mount The Inverter

1. Select an appropriate mounting location and orientation. The unit can be oriented in any way, such as:

- Horizontally on a vertical surface or

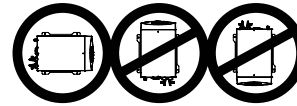

DC connections should NOT point up or down.

- On or under a horizontal surface.

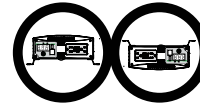

2. Hold the inverter against the mounting surface and mark the positions using the mounting flanges as guide.
3. Pilot-drill the four mounting holes.
4. Fasten the inverter to the mounting surface using corrosion-resistant hardware sized #10.

Connect the Chassis Ground

DANGER

ELECTRICAL SHOCK HAZARD

Never operate the PROwatt SW Inverter without connecting it to the ground.

Failure to follow these instructions will result in death or serious injury.

The PROwatt SW Inverter has a screw terminal labeled CHASSIS GND on the outside of the rear panel as shown in Figure 3, “PROwatt SW Inverter Back Panel (PROwatt SW 600 shown)” on page 5.

Follow the guidelines below to connect the inverter’s chassis to the ground.

Grounding Locations

The chassis ground terminal must be connected to a grounding point. The grounding point varies depending on where you install the PROwatt SW Inverter. Follow the guidelines that correspond to your type of installation.

Recreational Vehicle

Connect the CHASSIS GND screw to the vehicle’s chassis using a minimum 8 AWG copper wire^a (preferably with green/yellow insulation).

Fixed Location

Connect the CHASSIS GND screw to your system’s DC grounding point using a minimum 6 AWG wire^a. The system’s grounding point is usually the AC service entrance grounding point or a separate ground rod. For a solar PV (photovoltaic) installation, this is usually the same rod used to ground the PV array.

a.Xantrex recommends that the grounding conductor (grounding wire) should be the same wire size as the DC cables.

Connect The Battery Cables

IMPORTANT: Use of a qualified installer strongly recommended.

To operate safely and effectively, the PROwatt SW Inverter needs proper DC cables and DC-rated fuse(s). Because the PROwatt SW Inverter has low-voltage and high-current input, low-resistance wiring between the battery and the inverter is essential to deliver the maximum amount of usable energy to your load.

Installation

Cabling Guidelines

Follow these guidelines and refer to Table 1 : Voltage Drop Per Foot of DC Cable on page 10 to determine battery cable lengths.

- Use 4 AWG copper (90 °C insulation rating) as the smallest battery cable size. This will minimize the voltage drop between the battery and the inverter. If the cables cause an excessive voltage drop, the inverter may shut down when drawing higher currents because the voltage at the inverter input drops below 10.5 volts.
- Keep all cables as short as possible, and ensure that each cable between the inverter and the battery is no longer than 6 feet (1.8 m).
- Have all wires and cables terminated with correct and appropriately-sized connectors and have the connectors crimped at the place of purchase.
- Do not use aluminum. It has about 1/3 more resistance than copper cable of the same size, and it is difficult to make good, low-resistance connections to aluminum wire.

Table 1 : Voltage Drop Per Foot of DC Cable

		Inverter Output (W)			
		600	1000	1500	3000
		Current (A)			
		60	100	150	300
Wire Size (AWG)	Resistance (ohms/ft) @ 25 °C	Voltage Drop per Foot			
4	0.000253	0.0152	0.0253	0.0380	0.0759
3	0.000201	0.0121	0.0201	0.0302	0.0603
2	0.000159	0.0096	0.0159	0.0239	0.0477
1	0.000126	0.0076	0.0126	0.0189	0.0378
0	0.000100	0.0060	0.0100	0.0150	0.0300
2/0	0.000079	0.0048	0.0079	0.0119	0.0237
3/0	0.000063	0.0038	0.0063	0.0095	0.0189
4/0	0.000050	0.0030	0.0050	0.0075	0.0150

Note: Xantrex recommends a size 0 cable with a maximum cable length of 6 feet (1.8 m).

For example:

Note: Voltage Drop per foot = Current value × Resistance value

So for a 600 W inverter output with a DC cable of size 0, multiply the maximum current of 60 A with 0.000100. The result is 0.00600 voltage drop per feet. If the cable is 6 feet long, the total voltage drop is $0.00600 \times 6 (\times 2) = \mathbf{0.072}$. (Cable length multiplied by 2.)

So for a battery operating at 12.6 V at battery terminal the voltage at the inverter terminal drops to 12.53 V.

Fuse/Circuit Breaker Sizing Guidelines

Because batteries can produce thousands of amps, you are required to install DC-rated fuses (or circuit breakers) that can safely withstand the short-circuit current batteries can produce.

To select the correct fuse type and size:

1. Determine the total cold cranking amp rating for your battery(s).

Note: The cold cranking amp rating of each battery is displayed on the battery case. If it is not, contact the battery manufacturer to find out.

For example:

- If you are using one battery to power your inverter and its rating is 500, the total cold cranking amp rating is 500.
 - If you are powering your inverter with two batteries in parallel, and each has a rating of 500, the total cold cranking amp rating is 1000.
2. Once you have determined the total cold cranking amp rating of your batteries, identify the corresponding Ampere Interrupting Capacity (AIC) of the fuse or breaker required for your system by referring to Table 2.

Note: The AIC is the amount of battery short-circuit amperage that the fuse can safely withstand.

- If the Total Cold Cranking Amps indicate that the AIC is 2,700 amps or less, see Table 3 for the correct ANL fuse.
- If the Total Cold Cranking Amps indicate that the AIC is up to 200,000 amps or if you require a “code fuse”, see Table 3 for the correct Class T fuse.

Table 2 Cold Cranking Amps / AIC

Total Cold Cranking Amps	Ampere Interrupting Capacity (AIC)
650 or less	1500
651–1100	3000
over 1100	5000

Table 3 Fuse Ratings

Model	ANL Fuse	Class T
PROwatt SW 600	80 A	80 A
PROwatt SW 1000	150 A	150 A
PROwatt SW 2000	250 A	250 A

Installation

Cabling Procedure

Consult the following configurations and determine a match specific to your installation and follow the installation procedure “To connect the battery cables:” that comes next.

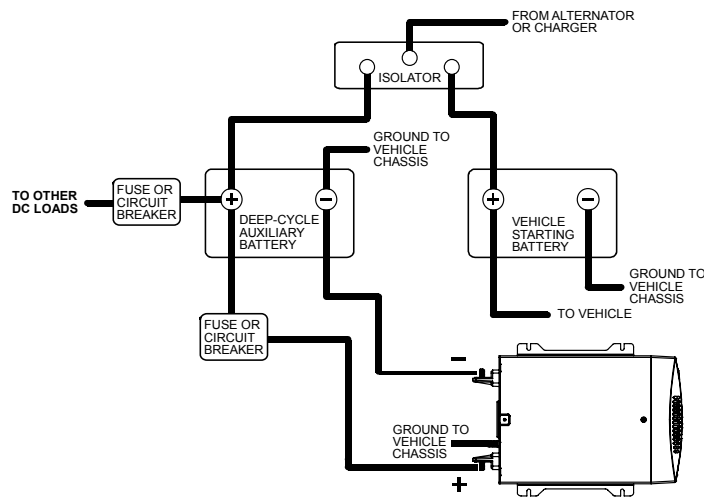

Figure 4 Configuration for Normal Loads

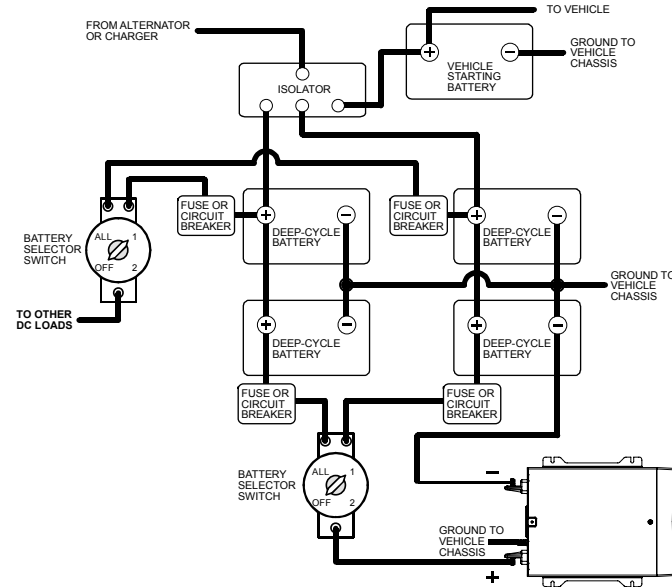

Figure 5 Configuration for Heavy Loads

To connect the battery cables:

1. Make sure the inverter is off and assemble the terminated cables (cables with connectors) that you bought.
2. Line up the connectors that will join the cables to the battery, battery selector switch, and fuse (or circuit breaker).

⚠ DANGER

ELECTRICAL SHOCK AND FIRE HAZARD

Install a DC-rated fuse (and fuse holder) on the positive battery terminal. Note that the PROwatt SW Inverter does not come with a DC-rated fuse (or circuit breaker) to safely withstand the short-circuit current batteries can produce.

Failure to follow these instructions will result in death or serious injury.

3. Install a DC-rated fuse on the positive battery terminal.
Alternatively, install a DC-rated circuit breaker that connects to the positive battery terminal.
The fuse (or circuit breaker) must have an Ampere Interrupting Capacity (AIC) that exceeds the short-circuit current available from the battery. For guidance, see “Cold Cranking Amps / AIC” on page 11.
4. When configuring for heavy loads (see Figure 5), install a battery selector switch and connect it to the DC-rated fuse (or circuit breaker).
5. On the inverter side, attach the connectors of the positive and negative cables into the cabling terminals of the inverter.

Note: Make a secure connection. Loose connectors cause excessive voltage drop and may cause overheated wires and melted insulation.

Note: The red terminal is positive (+) and the black terminal is negative (-). Power connections to the PROwatt SW Inverter must be positive to positive and negative to negative.

CAUTION

DAMAGE DUE TO REVERSE POLARITY

Do not connect positive cables to negative terminals (and vice-versa) as this will blow a fuse in the inverter and may permanently damage the unit. Damage caused by a reverse polarity connection is not covered by your warranty.

Failure to follow these instructions can damage the unit and/or damage other equipment.

6. Attach the connector on the positive cable to the DC-rated fuse (or circuit breaker) which is connected to the positive terminal of the battery.
When configuring for heavy loads (see Figure 5), attach the connector on the positive cable to the battery selector switch that is already connected to the DC-rated fuse (or circuit breaker).
Note: Make a secure connection. Loose connectors cause excessive voltage drop and may cause overheated wires and melted insulation.

Installation

DANGER

EXPLOSION AND FIRE HAZARD

Do not complete the next step if flammable fumes are present. Thoroughly ventilate the battery compartment before making this connection.

Failure to follow these instructions will result in death or serious injury.

7. Attach the connector on the negative cable to the negative battery terminal.
Note: This is the last cable connection. You may observe a spark when making this last connection.
Note: Make a secure connection. Loose connectors cause excessive voltage drop and may cause overheated wires and melted insulation.
8. If you have installed a battery selector switch, use it to select one of the batteries or battery banks.
9. Turn on the inverter.
10. Check the front panel of the inverter. The digital display should show 12–13 volts, depending on the voltage of the battery. If it does not, check your battery and the connection to the inverter. The other indicators should be off.

Operation

Turning the Inverter On and Off

The power switch on the inverter's front panel turns the control circuit in the PROwatt SW Inverter on and off.

To toggle the inverter on and off from its front panel:

1. Press the inverter's power switch button (for half a second) to turn On the inverter (from Off).
2. Press the inverter's power switch button (for one second) to turn Off the inverter (from On).

Note: When the inverter's power switch button is Off, the inverter draws no current from the battery.

IMPORTANT: The unit's power switch when turned off does not disconnect power from the PROwatt SW Inverter.

Operating Several Loads at Once

If you are going to operate several loads from the PROwatt SW Inverter, turn them on separately after you have turned the inverter on.

This will ensure that the inverter does not have to deliver the starting current for all the loads at once.

Turning the Inverter Off Between Charges

When the power switch is on but no power is being supplied to a load, the inverter draws less than 800 mA from the battery. This is a low current draw. It would take a week to discharge a 150 Ah battery at this current, so you don't have to worry about excessive drain on your battery if you leave the inverter switched on for a few days.

If you are not planning to recharge your battery within a week or so, switch the inverter off.

GFCI-Protected AC Outlets

The AC outlets are Ground Fault Circuit Interrupter (GFCI) outlets. This protects you against hazardous electrical shocks that could be caused by dampness, faulty mechanism in the appliance, worn insulation, etc. GFCI-protected outlets cut off hazardous electrical shocks quickly enough so an adult in normal health is not seriously injured (infants and small children may still be affected).

IMPORTANT: Test the GFCI periodically to make sure it is operating correctly.

Operation

To test (or reset) the GFCI protection:

1. Press the unit's power switch to turn the inverter On.
2. Plug a test lamp into the AC outlet.
3. Push the TEST button.

Note: The RESET button should pop out and the power should turn Off (the lamp should go out). If the lamp remains lit, or if the RESET button does not pop out, the GFCI may not be functioning.

If the GFCI trips by itself at any time, reset it and perform the preceding test.

Reading the Front Panel Indicators

Indicator LEDs

- If the Green LED is On, it indicates that the unit is On. Under normal operating conditions, the AC outlets and USB port have power. However, even under an error condition such as a shutdown, the Green LED may still remain On.
- If the Red LED is on, it indicates an error or alarm condition and an error code is displayed on the digital display underneath the LED.

Digital Display

- Under normal operating conditions, the digital display shows the input voltage (in volts) and the output power (in kilowatts).
- Under error or alarm conditions, the digital display shows an error code and the Red LED turns on.

Description of LED and Digital Display Codes

LED	Digital Display	Description
Green	13.5	Example: 13.5 volts
Green	0.25	Example: 0.25 Kw (250 watts)
Red	E 0 1	Under voltage alarm and/or Under voltage shutdown
Red	E 0 2	Over voltage shutdown
Red	E 0 3	Over load shutdown
Red	E 0 4	Over temperature shutdown
Red	E 1 0	Short circuit or output circuit overheat

Note: The audio alarm will sound for five minutes. After five minutes, the unit will turn off.

Restarting After an AC Output Shutdown

1. Press and hold the unit's power switch to turn it Off.
2. Remove all AC loads or let the unit cool down for 15 minutes.
3. Press and hold the unit's power switch to turn it On.

Operating Limits

Power Output

The PROwatt SW Inverter will deliver the following power continuously, depending on input voltage and ambient temperature. The inverter will deliver more than 10% of its continuous power rating for approximately five minutes. The inverter must cool down for 15 minutes before it can resume operation above its continuous power rating.

Model	Power ^a	Output Current ^b	Input Voltage	Temperature
PROwatt SW 600	540 W	4.5 A	13 Vdc	Ambient 25 °C (77 °F)
PROwatt SW 1000	900 W	7.5 A		
PROwatt SW 2000	1800 W	15 A		

a. Applies to resistive loads such as incandescent lights.

b. Applies to reactive loads such as motors.

Input Voltage

The input voltage limits are shown in the following table.

Operating Condition	Voltage Range	Comment
Normal	10.5–15.5 V	n/a

Peak Performance	13–14.5 V	n/a
Low Voltage Alarm	Voltage is 11.0 V or less	The audible low battery alarm sounds.
Operating Condition	Voltage Range	Comment
Low Voltage Shutdown	Voltage is 10.5 V or less.	The unit shuts down to protect the battery from being over-discharged.
High Voltage Shutdown	Voltage is 15.5 V or more.	The unit shuts down to protect itself from excessive input voltage. Note: Although the PROwatt SW Inverter incorporates over-voltage protection, it can still be damaged if input voltage exceeds 16 V.
Unit restarts after low voltage shutdown	11.5 V	The unit will not restart unless the battery voltage is acceptable for running the load.

Operation

Inverter Loads

The PROwatt SW Inverter will operate many AC loads within its power rating. However, some appliances and equipment may be difficult to operate. Please see “Exceptional Loads” below carefully.

USB Loads

A lot of USB-powered devices such as portable music (MP3) players, mobile phones, and video game players can be charged and powered safely via the standard USB port. However, some devices such as portable GPS receivers and certain cameras may not work and even cause damage even if you use the USB cable that came with the product. Be sure that the device only accepts 5 volts and can be charged or powered using other sources of power. See the device’s owner’s guide under specifications for information.

Exceptional Loads

Some induction motors used in freezers, pumps, and other motor-operated equipment need high surge currents to start. The PROwatt SW Inverter may not be able to start some of these motors even though their rated current draw is within the inverter’s limits.

If a motor refuses to start, observe the VOLTS indicator while you are trying to start the motor. If the indicator drops below 11 volts while the PROwatt SW Inverter is trying to start the motor, this may explain why the motor won’t start. Make sure the length and

diameter of the battery cables are appropriate. Check that the battery connections are good and that the battery is fully charged. If the cables are sized correctly, the connections are good, and the battery is charged, but the voltage still drops below 11 volts, you may need to use a larger battery.

Battery Charging Frequency

When possible, recharge your batteries when they are about 50% discharged or earlier. This gives them a much longer life cycle than recharging when they are almost completely discharged. For information about battery chargers, see our web site at www.xantrex.com.

Maintenance

Routine maintenance is required to keep your PROwatt SW Inverter operating properly. Periodically you should:

- Clean the exterior of the unit with a damp cloth to prevent the accumulation of dust and dirt.
- Tighten the screws on the DC input terminals.

Troubleshooting

⚠ DANGER

ELECTRICAL SHOCK HAZARD
 Do not dismantle the PROwatt SW Inverter. It does not contain any user-serviceable parts.
 Do not attempt to service the unit yourself.
Failure to follow these instructions will result in death or serious injury.

Troubleshooting Reference

Condition	Possible Cause	Solution
E 0 1	Under Voltage (low input) shutdown	Recharge the battery. Check cables and connection if secure.
E 0 1 with persistent low battery alarm.	Poor DC wiring and/or poor battery condition	Use proper cable and make secure connections. Charge the battery or install a new battery.

Condition	Possible Cause	Solution
E 0 2	Over Voltage (high input) shutdown	Make sure the inverter is connected to a 12 V battery.
E 0 3	Overload shutdown	Reduce the load within the inverter's continuous power rating.
E 0 4 Heavy load is connected then AC output becomes unavailable.	Over temperature shutdown	Allow the inverter to cool off and reduce the load if continuous operation is required.
E 0 4 Normal load is connected then AC output becomes unavailable.	Over temperature shutdown	Improve ventilation and make sure the inverter's ventilation openings are not obstructed. Reduce the ambient temperature, if possible.

Troubleshooting

Condition	Possible Cause	Solution	Condition	Possible Cause	Solution
E 10 No output voltage.	Short circuit	Check the AC wiring for a short circuit.	No output voltage; no voltage indication.	The unit is off.	Turn the inverter on.
	Very heavy load	Remove the load.		No power to the inverter.	Check wiring to the inverter.
	Output circuit overheat	Turn the unit off. Let the unit cool down, check the fan for any obstructions and clear it, or reduce the load. Turn the unit back on.		Inverter fuse open.	Have a qualified service technician check and replace the fuse if necessary.
			Reverse DC polarity.	Have a qualified service technician check and replace the fuse, making sure to observe correct polarity.	
			The unit is on and running but there is no AC output.	The GFCI device tripped.	Reset the GFCI. See page 16 for instructions.

Specifications

Note: Specifications are subject to change without prior notice.

Physical and Environmental Specifications

Length × Width × Height	12.2×8.7×3.5 inch. (31×22×8.9 cm)
<ul style="list-style-type: none"> • PROwatt SW 600 • PROwatt SW 1000 • PROwatt SW 2000 	<ul style="list-style-type: none"> • 14×9×3.5 inch. (35×22×8.5 cm) • 13.8×11.8×3.9 inch. (35×30×10 cm)
Weight	6.5 lbs. (3.0 kg)
<ul style="list-style-type: none"> • PROwatt SW 600 • PROwatt SW 1000 • PROwatt SW 2000 	<ul style="list-style-type: none"> • 7.2 lbs. (3.3 kg) • 10.6 lbs. (4.8 kg)
Operating temperature	32–104 °F (0–40 °C)

DC Input	600	1000	2000
Input power (max at full load)	720 VA	1200 VA	2400 VA
Input current (max at full load)	60 A	93 A	200 A
Input voltage range	10.5–15.5 Vdc		
Low battery alarm	Audible, 11 V		
Low battery cutout	10.5 V		

AC / USB Output	600	1000	2000
Peak power (5 minutes)	600 W	1000 W	2000 W
Continuous power	540 W	900 W	1800 W

AC / USB Output	600	1000	2000
Surge power	1200 W	2000 W	3000 W
Output current (continuous)	4.6 A	7.5 A	15 A
Output current (max)	5.8 A	9.6 A	19.2 A
No load current draw	< 600 mA	< 600 mA	< 800 mA
Output voltage (nominal)	120 Vac RMS ±5%		
Output voltage range	104–127 Vac		
Output waveform	True sine wave		
Output frequency	60 Hz ±0.5Hz		
Efficiency	Approximately 85–90%		
USB Output	5 Vdc, 500 mA		

Regulatory Approvals

UL 458 5th edition (including marine supplement)	Power Converters/Inverters and Power Converter/ Inverter Systems for Land Vehicles and Marine Crafts
CSA 107.1-01	General Use Power Supplies
FCC Part 15, Class A	Electromagnetic Compatibility (EMC)

Warranty and Return Information

Warranty

What does this warranty cover and how long does it last? This Limited Warranty is provided by Xantrex Technology USA Inc. ("Xantrex") and covers defects in workmanship and materials in your PROwatt™ SW Sine Wave Inverter. This warranty period lasts for 24 Months from the date of purchase at the point of sale to you, the original end user customer, unless otherwise agreed in writing (the "Warranty Period"). You will be required to demonstrate proof of purchase to make warranty claims.

This Limited Warranty is transferable to subsequent owners but only for the unexpired portion of the Warranty Period. Subsequent owners also require original proof of purchase as described in "What proof of purchase is required?"

What will Xantrex do? During the Warranty Period Xantrex will, at its option, repair the product (if economically feasible) or replace the defective product free of charge, provided that you notify Xantrex of the product defect within the Warranty Period, and provided that Xantrex through inspection establishes the existence of such a defect and that it is covered by this Limited Warranty.

Xantrex will, at its option, use new and/or reconditioned parts in performing warranty repair and building replacement products. Xantrex reserves the right to use parts or products of original or improved design in the repair or replacement. If Xantrex repairs or replaces a product, its warranty continues for the remaining portion of the original Warranty Period or 90 days from the date of the

return shipment to the customer, whichever is greater. All replaced products and all parts removed from repaired products become the property of Xantrex.

Xantrex covers both parts and labor necessary to repair the product, and return shipment to the customer via a Xantrex-selected non-expedited surface freight within the contiguous United States and Canada. Alaska, Hawaii and outside of the United States and Canada are excluded. Contact Xantrex Customer Service for details on freight policy for return shipments from excluded areas.

How do you get service? If your product requires troubleshooting or warranty service, contact your merchant. If you are unable to contact your merchant, or the merchant is unable to provide service, contact Xantrex directly at:

Telephone: 1 800 670 0707 (toll free North America)

Fax: 1 800 994 7828 (toll free North America)

Email: customerservice@xantrex.com

Website: www.xantrex.com

Direct returns may be performed according to the Xantrex Return Material Authorization Policy described in your product manual. For some products, Xantrex maintains a network of regional Authorized Service Centers. Call Xantrex or check our website to see if your product can be repaired at one of these facilities.

Warranty and Return Information

What proof of purchase is required? In any warranty claim, dated proof of purchase must accompany the product and the product must not have been disassembled or modified without prior written authorization by Xantrex.

Proof of purchase may be in any one of the following forms:

- The dated purchase receipt from the original purchase of the product at point of sale to the end user; or
- The dated dealer invoice or purchase receipt showing original equipment manufacturer (OEM) status; or
- The dated invoice or purchase receipt showing the product exchanged under warranty.

What does this warranty not cover? Claims are limited to repair and replacement, or if in Xantrex's discretion that is not possible, reimbursement up to the purchase price paid for the product. Xantrex will be liable to you only for direct damages suffered by you and only up to a maximum amount equal to the purchase price of the product.

This Limited Warranty does not warrant uninterrupted or error-free operation of the product or cover normal wear and tear of the product or costs related to the removal, installation, or troubleshooting of the customer's electrical systems. This warranty does not apply to and Xantrex will not be responsible for any defect in or damage to:

- a) the product if it has been misused, neglected, improperly installed, physically damaged or altered, either internally or externally, or damaged from improper use or use in an unsuitable environment;
- b) the product if it has been subjected to fire, water, generalized corrosion, biological infestations, or input voltage that creates

operating conditions beyond the maximum or minimum limits listed in the Xantrex product specifications including but not limited to high input voltage from generators and lightning strikes;

- c) the product if repairs have been done to it other than by Xantrex or its authorized service centers (hereafter "ASCs");
- d) the product if it is used as a component part of a product expressly warranted by another manufacturer;
- e) component parts or monitoring systems supplied by you or purchased by Xantrex at your direction for incorporation into the product;
- f) the product if its original identification (trade-mark, serial number) markings have been defaced, altered, or removed;
- g) the product if it is located outside of the country where it was purchased; and
- h) any consequential losses that are attributable to the product losing power whether by product malfunction, installation error or misuse.

Warranty and Return Information

Disclaimer

Product

THIS LIMITED WARRANTY IS THE SOLE AND EXCLUSIVE WARRANTY PROVIDED BY XANTREX IN CONNECTION WITH YOUR XANTREX PRODUCT AND IS, WHERE PERMITTED BY LAW, IN LIEU OF ALL OTHER WARRANTIES, CONDITIONS, GUARANTEES, REPRESENTATIONS, OBLIGATIONS AND LIABILITIES, EXPRESS OR IMPLIED, STATUTORY OR OTHERWISE IN CONNECTION WITH THE PRODUCT, HOWEVER ARISING (WHETHER BY CONTRACT, TORT, NEGLIGENCE, PRINCIPLES OF MANUFACTURER'S LIABILITY, OPERATION OF LAW, CONDUCT, STATEMENT OR OTHERWISE), INCLUDING WITHOUT RESTRICTION ANY IMPLIED WARRANTY OR CONDITION OF QUALITY, MERCHANTABILITY OR FITNESS FOR A PARTICULAR PURPOSE. ANY IMPLIED WARRANTY OF MERCHANTABILITY OR FITNESS FOR A PARTICULAR PURPOSE TO THE EXTENT REQUIRED UNDER APPLICABLE LAW TO APPLY TO THE PRODUCT SHALL BE LIMITED IN DURATION TO THE PERIOD STIPULATED UNDER THIS LIMITED WARRANTY.

IN NO EVENT WILL XANTREX BE LIABLE FOR: (a) ANY SPECIAL, INDIRECT, INCIDENTAL OR CONSEQUENTIAL DAMAGES, INCLUDING LOST PROFITS, LOST REVENUES, FAILURE TO REALIZE EXPECTED SAVINGS, OR OTHER COMMERCIAL OR ECONOMIC LOSSES OF ANY KIND, EVEN IF XANTREX HAS BEEN ADVISED, OR HAD REASON TO KNOW, OF THE POSSIBILITY OF SUCH DAMAGE; (b) ANY LIABILITY ARISING IN TORT, WHETHER OR NOT ARISING OUT OF XANTREX'S NEGLIGENCE, AND ALL LOSSES OR DAMAGES TO ANY PROPERTY OR FOR ANY PERSONAL INJURY OR ECONOMIC LOSS OR DAMAGE CAUSED BY THE CONNECTION OF A PRODUCT TO ANY OTHER DEVICE OR SYSTEM; AND (c) ANY DAMAGE OR INJURY ARISING FROM OR AS A RESULT OF MISUSE OR ABUSE, OR THE INCORRECT INSTALLATION, INTEGRATION OR OPERATION OF THE PRODUCT BY PERSONS NOT AUTHORIZED BY XANTREX.

Exclusions

IF THIS PRODUCT IS A CONSUMER PRODUCT, FEDERAL LAW DOES NOT ALLOW AN EXCLUSION OF IMPLIED WARRANTIES. TO THE EXTENT YOU ARE ENTITLED TO IMPLIED WARRANTIES UNDER FEDERAL LAW, TO THE EXTENT PERMITTED BY APPLICABLE LAW THEY ARE LIMITED TO THE DURATION OF THIS LIMITED WARRANTY. SOME STATES, PROVINCES AND JURISDICTIONS DO NOT ALLOW LIMITATIONS OR EXCLUSIONS ON IMPLIED WARRANTIES OR ON THE DURATION OF AN IMPLIED WARRANTY OR ON THE LIMITATION OR EXCLUSION OF INCIDENTAL OR CONSEQUENTIAL DAMAGES, SO THE ABOVE LIMITATION(S) OR EXCLUSION(S) MAY NOT APPLY TO YOU. THIS LIMITED WARRANTY GIVES YOU SPECIFIC LEGAL RIGHTS. YOU MAY HAVE OTHER RIGHTS WHICH MAY VARY FROM STATE TO STATE, PROVINCE TO PROVINCE OR JURISDICTION TO JURISDICTION.

Return Material Authorization Policy

For those products that are not being repaired in the field and are being returned to Xantrex, before returning a product directly to Xantrex you must obtain a Return Material Authorization (RMA) number and the correct factory "Ship To" address. Products must also be shipped prepaid. Product shipments will be refused and returned at your expense if they are unauthorized, returned without an RMA number clearly marked on the outside of the shipping box, if they are shipped collect, or if they are shipped to the wrong location.

When you contact Xantrex to obtain service, please have your instruction manual ready for reference and be prepared to supply:

- The serial number of your product
- Information about the installation and use of the unit
- Information about the failure and/or reason for the return
- A copy of your dated proof of purchase

Record these details on page 26.

Return Procedure

Package the unit safely, preferably using the original box and packing materials. Please ensure that your product is shipped fully insured in the original packaging or equivalent. This warranty will not apply where the product is damaged due to improper packaging.

Include the following:

- The RMA number supplied by Xantrex Technology USA Inc. clearly marked on the outside of the box.
- A return address where the unit can be shipped. Post office boxes are not acceptable.
- A contact telephone number where you can be reached during work hours.
- A brief description of the problem.

Ship the unit prepaid to the address provided by your Xantrex customer service representative.

If you are returning a product from outside of the USA or Canada In addition to the above, you **MUST** include return freight funds and are fully responsible for all documents, duties, tariffs, and deposits.

If you are returning a product to a Xantrex Authorized Service Center (ASC) A Xantrex return material authorization (RMA) number is not required. However, you must contact the ASC prior to returning the product or presenting the unit to verify any return procedures that may apply to that particular facility and that the ASC repairs this particular Xantrex product.

Warranty and Return Information

Information About Your System

As soon as you open your PROwatt™ SW Sine Wave Inverter package, record the following information and be sure to keep your proof of purchase.

- Serial Number _____
- Product Number/s 806-1206
 806-1210
 806-1220
- Purchased From _____
- Purchase Date _____

If you need to contact Customer Service, please record the following details before calling. This information will help our representatives give you better service.

- Type of installation (e.g. RV, truck) _____
- Length of time inverter has been installed _____
- Battery/battery bank size _____

- Battery type (e.g. flooded, sealed gel cell, AGM) _____
- DC wiring size and length _____
- Alarm sounding? _____
- Description of indicators on front panel _____
- Appliances operating when problem occurred _____
- Description of problem _____

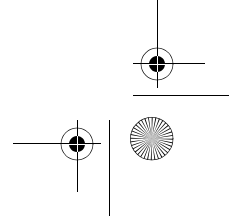
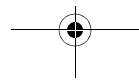
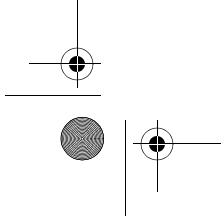
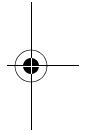
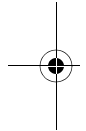
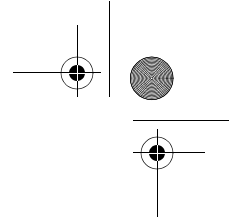
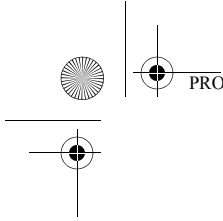

Xantrex Technology USA Inc.

1 800 670 0707 Tel toll free NA
1 800 994 7828 Fax toll free NA
customerservice@xantrex.com
www.xantrex.com

975-0529-01-01

Printed in China