

BatteryMINDER®

36-Volt 36271 and 48-Volt 48021 Battery Maintainer-Desulfators INSTRUCTION MANUAL*



All Models Include:

- ATS Temperature Sensor (installed)
- Ring Terminals with 15A Fuse
- EZC-01 EZ Connector + Mounting Screws



- Designed to be used with your vehicle's "stock-bulk" charger. The BatteryMINDER takes over when the original supplied charger shuts off. See the accompanying addendum for more details.
- NOT for use with Aviation-type batteries

READ AND SAVE THESE INSTRUCTIONS

VDC Electronics, Inc. • 155 W. Carver St., Ste. 2 • Huntington, NY 11743
www.BatteryMINDers.com • techsupport@vdcelectronics.com

Table Of Contents

Required Safety Instructions	3
Preparing to Charge	5
Charger Location	5
DC Connection Precautions	5
Qualifying Your Battery	7
Testing a Filler Cap Lead-Acid Battery	7
Specific Gravity – Capacity Table.	9
Testing With a Hot/Cold Calibrated Hydrometer Tester	9
Testing A Sealed, AGM or Flooded (Wet-Cell) Lead Acid Battery	9
Use a Digital Voltmeter Only	9
OCV/Full Capacity Table	10
Unit Labels	11
Simplified Operating Instructions	12
Common Features	13
Battery Condition Table	14
LED Status Table.	14
Detailed Operating Instructions	15
Multi-Battery Configuration	18
Charge and Float Voltages at Various Temperature Ranges	19
Maintaining Multiple Batteries.	20
Troubleshooting	21
For Repair or Replacement / Registration	23
Guarantee / Warranty	24

Glossary of Terms

- Maintain a battery**
 BatteryMINDER ensures batteries are truly fully charged and will likely continue improving the condition of the battery to the fullest extent possible.
- Rested**
 A battery that has been as fully charged as possible and left disconnected from charger or any type load overnight.
- Specific Gravity**
 One of the key parameters of battery operation is the specific gravity of the electrolyte. Specific gravity is the ratio of the weight of a solution to the weight of an equal volume of water at a specified temperature. Specific gravity is used as an indicator of the state of charge of a cell or battery.
- Sulfation**
 Occurs when the battery sits for long periods of time and the electrolyte solution begins to break down. Sulfur in the solution leaches from the electrolyte, sticking to the lead plates as converted lead sulfuric crystals.

REQUIRED SAFETY INSTRUCTIONS**WARNING****READ AND FULLY UNDERSTAND BEFORE OPERATING**

Contact VDC Electronics if uncertain about any settings or operation.

TO REDUCE THE RISK OF FIRE, ELECTRIC SHOCK, OR INJURY TO PERSON, OBSERVE THE FOLLOWING:

- 1. SAVE THESE INSTRUCTIONS**
2. This manual contains important safety and operating instructions for BatteryMINDer Models **36271** and **48021**.
3. Do not expose charger to rain or snow.
4. Use of an attachment not recommended or sold by VDC Electronics may result in a risk of fire, electric shock, or injury to persons.
5. To reduce risk of damage to electric plug and cord, pull by plug rather than cord when disconnecting charger.
6. An extension cord should not be used unless absolutely necessary. Use of improper extension cord could result in a risk of fire and electric shock. If an extension cord must be used, make sure:
 - That pins on plug of extension cord are the same number, size, and shape as those of plug on charger;
 - That extension cord is properly wired and in good electrical condition; and
 - That wire size is large enough for ac ampere rating of charger as specified in Table below.
7. Do not operate charger with damaged cord or plug – replace the cord or plug immediately.
8. Do not operate charger if it has received a sharp blow, been dropped, or otherwise damaged in any way; call **VDC Electronics Tech**

Recommended minimum AWG size for extension cords for battery chargers					
AC input rating, amperes^a		AWG size of cord			
Equal to or greater than	But less than	Length of cord, feet (m)			
		25 (7.6)	50 (15.2)	100 (30.5)	150 (45.6)
0	2	18	18	18	16
^a If the input rating of a charger is given in watts rather than in amperes, the corresponding ampere rating is to be determined by dividing the wattage rating by the voltage rating - for example: 1250 watts/125 volts = 10 amperes					

Support Dept. 800.379.5579 x6 (ET) for advice.

9. Do not disassemble charger; call **VDC Electronics Tech Support Dept. 800.379.5579 x6 (ET)** for advice when service or repair is required. Incorrect reassembly may result in a risk of electric shock or fire.
10. To reduce risk of electric shock, unplug charger from outlet before attempting any maintenance or cleaning. Turning off controls will not reduce this risk.

11. WARNING – RISK OF EXPLOSIVE GASES

- a. **WORKING IN VICINITY OF A LEAD-ACID BATTERY IS DANGEROUS. BATTERIES GENERATE EXPLOSIVE GASES DURING NORMAL BATTERY OPERATION. FOR THIS REASON, IT IS OF UTMOST IMPORTANCE THAT YOU FOLLOW THE INSTRUCTIONS EACH TIME YOU USE THE CHARGER.**
- b. To reduce risk of battery explosion, follow these instructions and those published by manufacturer of any equipment you intend to use in vicinity of battery. Review cautionary marking on these products and on engine.

12. PERSONAL PRECAUTIONS

- a. Consider having someone close enough by to come to your aid when you work near a lead-acid battery.
- b. Have plenty of fresh water and soap nearby in case battery acid contacts skin, clothing, or eyes.
- c. Wear complete eye protection and clothing protection. Avoid touching eyes while working near battery.
- d. If battery acid contacts skin or clothing, wash immediately with soap and water. If acid enters eye, immediately flood eye with running cold water for at least 10 minutes and get medical attention immediately.
- e. NEVER smoke or allow a spark or flame in vicinity of battery or engine.
- f. Be extra cautious to reduce risk of dropping a metal tool onto battery. It might spark or short-circuit battery or other electrical part that may cause explosion.
- g. Remove personal metal items such as rings, bracelets, necklaces, and watches when working with a lead-acid battery. A lead-acid battery can produce a short-circuit current high enough to weld a ring or the like to metal, causing a severe burn.
- h. Use charger for charging a LEAD-ACID battery only. It is not intended to supply power to a low voltage electrical system other than in a starter-motor application. Do not use battery charger

for charging dry-cell batteries that are commonly used with home appliances. These batteries may burst and cause injury to persons and damage to property.

- i. NEVER charge a frozen battery or a battery at a temperature above 123° F.

13. PREPARING TO CHARGE

- a. If necessary to remove battery from vehicle to charge, always remove grounded terminal from battery first. Make sure all accessories in the vehicle are off, so as not to cause an arc.
- b. Be sure area around battery is well ventilated while battery is being charged.
- c. Clean battery terminals. Be careful to keep corrosion from coming in contact with eyes.
- d. Add distilled water in each cell until battery acid reaches level specified by battery manufacturer. Do not overfill. For a battery without removable cell caps, such as valve regulated lead acid batteries, carefully follow manufacturer's recharging instructions.
- e. Study all battery manufacturer's specific precautions while charging and recommended rates of charge.
- f. Determine voltage of battery by referring to car owner's manual and make sure it matches output rating of battery charger.

14. CHARGER LOCATION

- a. Locate charger as far away from battery as DC cables permit.
- b. Never place charger directly above battery being charged; gases from battery will corrode and damage charger.
- c. Never allow battery acid to drip on charger when reading electrolyte specific gravity or filling battery.
- d. Do not operate charger in a closed-in area or restrict ventilation in any way.
- e. Do not set a battery on top of charger.
- f. Always mount units in vertical position with cord sets exiting downward to ensure weather tight integrity. Unit must be mounted in this manner to ensure long term trouble free life including weatherproof integrity. **Mounting in any other manner or using un-mounted (parallel to ground) except indoors may cause unit to fail due to water intrusion that is unable to drain correctly to avoid damage.**

15. DC CONNECTION PRECAUTIONS

- a. Connect and disconnect DC output clips only after setting any charger switches to "off" position and removing ac cord from electric outlet. Never allow clips to touch each other.
- b. Attach clips to battery and chassis as indicated

in 15(e), 15(f), and 16(b) through 16(d).

16. FOLLOW THESE STEPS WHEN BATTERY IS INSTALLED IN VEHICLE. A SPARK NEAR BATTERY MAY CAUSE BATTERY EXPLOSION. TO REDUCE RISK OF A SPARK NEAR BATTERY:

- a. Position AC and DC cords to reduce risk of damage by hood, door, or moving engine part.
- b. Stay clear of fan blades, belts, pulleys, and other parts that can cause injury to persons.
- c. Check polarity of battery posts. POSITIVE (POS, P, +) battery post usually has larger diameter than NEGATIVE (NEG, N, -) post.
- d. Determine which post of battery is grounded (connected) to the chassis. If negative post is grounded to chassis (as in most vehicles), see (e). If positive post is grounded to the chassis, see (f).
- e. When disconnecting charger, turn switches to off, disconnect AC cord, remove clip from vehicle chassis, and then remove clip from battery terminal.
- f. See operating instructions for length of charge information.

17. FOLLOW THESE STEPS WHEN BATTERY IS OUTSIDE VEHICLE. A SPARK NEAR THE BATTERY MAY CAUSE BATTERY EXPLOSION. TO REDUCE RISK OF A SPARK NEAR BATTERY:

- a. Check polarity of battery posts. POSITIVE (POS, P, +) battery post usually has a larger diameter than NEGATIVE (NEG, N, -) post.
- b. Attach at least a 24-inch-long 6-gauge (AWG) insulated battery cable to NEGATIVE (NEG, N, -) battery post.
- c. Connect POSITIVE (**RED**) charger clip to POSITIVE (POS, P, +) post of battery.
- d. Position yourself and free end of cable as far away from battery as possible – then connect NEGATIVE (**BLACK**) charger clip to free end of cable.
- e. Do not face battery when making final connection.
- f. When disconnecting charger, always do so in reverse sequence of connecting procedure and break first connection while as far away from battery as practical.
- g. A marine (boat) battery must be removed and charged on shore. To charge it on board requires equipment specially designed for marine use.

QUALIFYING YOUR BATTERY:**Preliminary Requirements**

NOTE: The BatteryMINDer has no electrical output unless it is connected to a healthy battery. Testing the BatteryMINDER with a volt or an Amp meter without the unit being connected across a good battery will result in a false reading. If you experience any problems, or are not sure of how to properly use or connect your BatteryMINDER, please e-mail our technical support at: techsupport@vdcelectronics.com or call our toll-free technical support line 800-379-5579 x6 (Eastern Time). **Be certain to leave your phone number with the area code, time zone and the best time to call.**

To gain the best result from your new charger and to maximize the life and performance of your batteries we strongly recommend you qualify (test) your batteries before attempting to either charge-maintain or desulfate them. Remember, even if you just purchased a “new” battery it may have been subjected to conditions that have caused “sulfation” such as high temperature ($\geq 80^\circ$).

NOTE: If your battery is new and you are certain it was not subject to conditions that could have caused sulfation*, even before you purchased it, then you can disregard our recommendations for qualifying / testing your battery, before using the BatteryMINDER.

* Such as high temperature storage ($\geq 80^\circ\text{F}$) and/or allowed to self-discharge to **37.2 Volts / 49.6 Volts** or lower.

Testing a Filler Cap or Manifold-type Lead Acid Battery

1. Carefully remove all caps from your battery.
2. Check the water-liquid electrolyte level. If the level is low or has ever been below top of plates, severe lead plate sulfation has taken place. Significant recharge/reconditioning time is needed to restore these plates to a condition where the battery can be expected to function normally.
3. Refill each cell with distilled water only to the liquid level indicator found in each cell. **Before proceeding further you must be thoroughly familiar with the safety and operating instructions.**
4. Recharge the battery with the BatteryMINDER to ensure that it is slowly and completely charged before you determine its condition. Allow battery to “rest” (see **Glossary of Terms**) overnight for a minimum of 12 hours before testing with a temperature compensated hydrometer and/or digital type voltmeter only.

Specific Gravity – Capacity	
Temperature Compensated Hydrometer - Meter or 4 ball type	Full Capacity Percentage
1.270 (4 Balls floating)	100%
1.250 (3 Balls floating)	75%
1.190 (2 Balls floating)	50%
1.150 (1 Balls floating)	25%
1.120 (0 Balls floating) May denote shorted cell or battery that has been severely discharged and may not be recoverable	0%

Testing with a Hot/Cold Calibrated Hydrometer Tester

Read the tester instructions carefully for most accurate readings.

1. When using the tester the first time or after a long period of non-use, fill the tester with the battery fluid and let it sit for 1/2 hour or longer. This will soak the balls in order to give you more accurate readings. Failure to do so will give you false readings indicating a battery that may not be in as good a condition as you may have thought.
2. After inserting the tester in a cell, gently tap the tester several times against the inside wall of each cell to dislodge air bubbles that will cause more balls to float than should. Failure to do so will yield false readings that indicate a battery that is not fully desulfated or does not qualify for desulfation.
3. If no balls float in any cell, the cell is shorted. This means your battery is beyond the point of being properly recharged or reconditioned-desulfated. Dispose of the battery.
4. If each cell floats three (3) or more balls (or 1250 on gauge-type), your battery can be desulfated-reconditioned.
5. Always rinse the tester with fresh water after every use. Failure to do so will cause false readings.

Testing a Sealed, AGM or GEL Lead Acid Battery

These batteries have no filler caps or manifold-type covers. Because you cannot gain access to the interior of your battery you cannot test it with a hydrometer.

USE A DIGITAL VOLTMETER ONLY:

1. Recharge the battery with the BatteryMINDer to ensure it is as completely charged as possible, before you determine its condition. Allow battery to “rest” (see ***Glossary of Terms***) overnight for a minimum of 12 hours before testing with a digital voltmeter only. Failure to test a “rested” battery will cause false readings. Be certain to read and understand all safety related instructions (pages 3 to 6) before proceeding further.
2. Measure battery’s voltage, without any load attached. If the voltage is less than **37.2 volts / 49.6 volts** (Typically 50% of charge) the battery may be too heavily sulfated to be fully recoverable. If voltage is **37.2V / 49.6V** or higher full recovery can be expected, given sufficient time (average 1-2 weeks for batteries that are heavily sulfated).

3. Connect the BatteryMINDER to the battery.
4. Charge battery to its maximum level. Allow battery to remain for a minimum of 72 hours before retesting. If improvement is seen, continue until battery voltage reaches full capacity level or no further increase is seen.

OCV=Open Circuit No Load Voltage		
OCV - "Rested" Voltage		Full Capacity Percentage
36V	48V	
38.7 - 39.3	51.6 - 52.4 Volts	100%
37.8 - 38.7	50.4 - 51.6 Volts	75%
37.2 - 37.8	49.6 - 50.4 Volts	50%
36.6 - 37.2	48.8 - 49.6 Volts	25%
36.0 - 36.6	48.0 - 48.8 Volts	0%
<33 Volts = shorted	<44 Volts = shorted	

Note: OPTIMA brand "Yellow Top" starter/deep cycle batteries have a fully charged "resting" voltage of **39.3 / 52.4 (OCV)**. Increase above values accordingly.

BatteryMINDER®

Battery Maintainer - Desulfator
Model 36271
36-Volt @ 2.7 Amp

For Sealed or Filler Cap
Lead-Acid Batteries ONLY

VDC Electronics, Inc.
800-379-5579 (ET)
www.BatteryMINDers.com

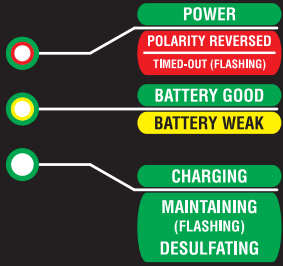
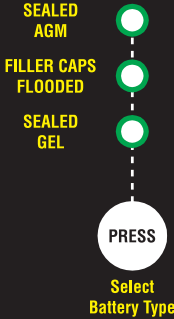

Please see Instruction Manual for additional explanation of all functions

BatteryMINDER®

Battery Maintainer - Desulfator
Model 48021
48-Volt @ 2 Amp

For Sealed or Filler Cap
Lead-Acid Batteries ONLY

VDC Electronics, Inc.
800-379-5579 (ET)
www.BatteryMINDers.com

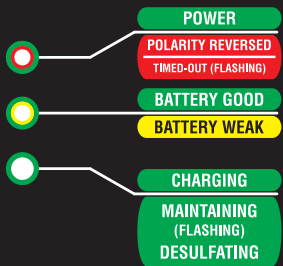
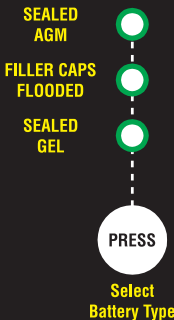

Please see Instruction Manual for additional explanation of all functions

SIMPLIFIED OPERATING INSTRUCTIONS

Read and thoroughly understand ALL SAFETY Instructions, pages 3 - 10 including *Preparing to Charge, DC Connection Precautions, Unit Location and Qualifying Your Battery* BEFORE proceeding further.

1. Attach a battery connector assembly, **Ring Terminal Assembly (7)** (supplied) or **EZC-01 EZ Connector (8)**, to output cordset of charger **(3)** - see Detailed Operating Instruction on page 15 for information on the **EZC-01**.
2. Attach output to battery terminals:
RED band = Positive +
BLACK band = Negative -.
3. Ambient Temperature Sensor, **ATS-1 (9)**, comes already installed on the Temperature Sensor input connector **(2)**. Do not detach.
4. Plug **AC power cord (5)** into a 120 Vac electrical outlet.
Observe Reversed Polarity **GREEN/RED** LED indicator **(1a)**:
If lit RED, reverse battery connector attachments on battery.
5. Observe **Charging/Maintaining GREEN** LED indicator **(1c)**:
Solid = *charging*
Blinking = *maintaining battery(s)*.
Charger will automatically start within 30 seconds or less.
6. Observe **Battery Connected - Error** LED Indicator **(1a)**:
Must be lit **GREEN**¹.

If in Doubt Regarding Any of the Above, Refer to **Detailed Operating Instructions**.

¹ See full instructions if not lit **GREEN**.

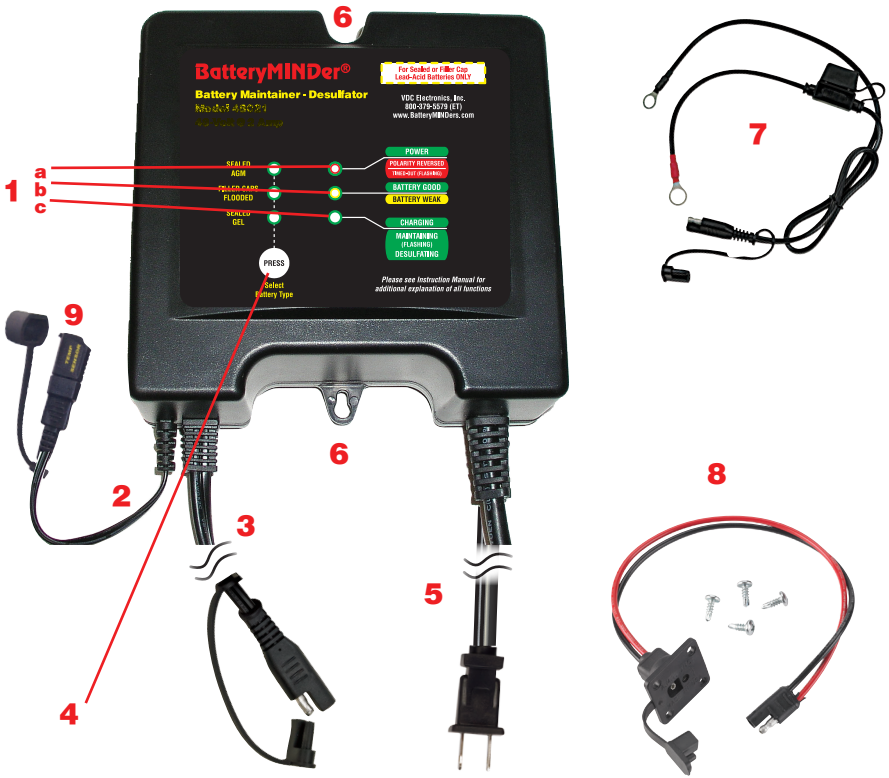



Common Features (Both Models)	
1	LED indicators (a, b & c) for power, connection, fault, battery, charge status
2	Temperature Sensor input connector
3	Output cord with quick connect plug
4	Battery Type selection button
5	Input power cordset
6	Mounting tabs
7	Ring Terminal cordset with quick connect plug (included)
8	EZC-01 EZ Connector with screws (included)
9	ATS-1 Ambient Temperature Sensor (included, shown installed on 2)

LED INDICATOR FUNCTIONS

Battery Condition Table			
Battery Condition	Battery Voltage (Vb)		
	36271	48021	
BEFORE full charge	<33	<44	Yellow
	>33	>44	Green
Stop/Restart during charging mode			REBOOT to restart*
AFTER full charge	Low Voltage		Yellow
	Normal Voltage		Green

*To REBOOT: Disconnect A.C. wall power, disconnect D.C. Battery power and wait 10 seconds

LED Status Table		
LED Status (Power/Error and Charging/Maintaing LEDs)		
A.C. power disconnected, battery connected correctly	OFF	OFF
At SoftStart mode, Bulk charge mode or Absorption mode	ON	ON
Float charge mode	ON	FLASHING
A.C. power connected Reversed Battery Polarity	ON	OFF
A.C. power connected, charger output clip shorted	ON	OFF
A.C. power connected, battery voltage <9V (36271) or <12V (48021)	ON	OFF
Timed-out when in SoftStart or Bulk mode	FLASHING	OFF
Timed-out when in Absorption mode & Forced to Float mode	FLASHING	FLASHING
Battery Fault / Battery Weak	FLASHING	OFF

Detailed Operation Instructions for Models 36271 and 48021

After carefully reading and understanding the Safety Instructions contained in this manual (pages 3 - 6) and having evaluated your battery as described in Qualifying Your Battery (pages 7 - 10) you are properly prepared to begin using your charger.

1. Attach output cord of charger to the Ring Terminal Assembly (RTA) (supplied).
Note: An **optional** method of connecting the BatteryMINDer to the RTA is with the EZC-01 panel mounted assembly (supplied). This connector is mounted through the side of the battery box under the golf cart seat, making it convenient to connect the BatteryMINDer without lifting the seat.
To install:
 - a. Drill a small pilot hole
 - b. Use a 7/8" or 1" hole saw (available at such stores as Home Depot) to complete drilling the hole.
 - c. Insert the EZC-01 into the hole and mark the four locations to drill the pilot holes for the screws (supplied).
 - d. Install the screws
 - e. Connect the EZC-01 to the Ring Terminal Assembly.
Note the BatteryMINDer cord must be removed by pulling on the connector plug, not the cord. Any damage to the connectors or cord will not be covered by the warranty.
2. **Never use either of these assemblies on any other charger or for any other purpose such as improvised "jumper cables", etc.**
3. Using the RTA on batteries remaining in their normal use location (in same place they are regularly installed will normally prove the safest and most convenient. If you have several applications you may wish to purchase additional Ring Terminal Assemblies (RTA) available from your dealer or VDC Electronics, Inc. directly.
4. **Note: this assembly contains a 15 Amp automotive type fuse and is replaceable should for any reason it were to blow. Never replace this fuse with any type whose rating is higher than 15 Amps, as seriously harmful results may occur.**
5. Identify the positive and negative posts or connections on your battery, usually clearly designated with the polarity markings of + (positive) and - (negative). If you have previously installed the RTA referred to in 1. above, you need only to press the connector plug of the charger's output cord into the mating plug of the RTA. Push firmly and do not leave any

space between them. Correct polarity and a good connection will be your reward.

6. Determine the type of battery you wish to charge. When certain press the **Select Battery Type** button. The most common is the **Flooded** kind, distinguished by removable filler caps (6) or two (2) manifold covers (Maintenance-Free) which should not be removed unless specifically allowed by the battery manufacturer. The second most popular is the **Absorbed Glass Mat (AGM)** sealed-valve regulated type. Lastly is the sealed valve regulated **GEL** battery.
Note: If unsure of your battery type, check with the battery seller, manufacturer or our Tech Support before proceeding further. The normal (default) setting of your charger is GEL, as this is the lowest voltage output and thus the one least likely to cause your battery to be overcharged, should you incorrectly select the wrong battery type. However be aware that using the wrong setting for a particular type battery can dramatically shorten its life and/or cause potentially explosive gas to be emitted from the battery.
7. After selecting both battery type plug the unit's power cord into a standard – grounded 120 Vac electrical outlet. The Power ON LED Indicator will light **GREEN**. If it does not light **GREEN** check the outlet to be sure it is functioning. In addition, be sure if outlet is controlled by a switch, no one will accidentally shut off the power to the outlet. Check for correct polarity = (no ERROR **RED** LED Indicator). If ERROR Indicator is lit, reverse the charger's output connections to the battery.
8. The Charge – Float LED Indicator will light **GREEN**. The charger will now begin charging by first checking the battery to determine its voltage and ability to accept a charge. Should the battery not have a normal fully discharged voltage (**31.5V [36271]** / **42.0V [48021]** minimum) the unit will begin charging in the "Soft-Start" mode to determine if the battery can be safely charged. If it cannot, the Power ON – Error LED will flash **RED** and charging will be stopped. Battery should be carefully checked under a load by a qualified person before further attempting to charge it.
9. **Note: If the battery does not have a minimum no load OCV (Open Circuit Voltage) of 36 Volts / 48 Volts, the ERROR LED will light RED and charger will reject battery.**
10. No further effort should be made to charge this battery with this charger or any charger. Discard this battery, unless it has just been subjected to a long period of continuous discharge under a load such as can occur with

leaving lights on or cranking an engine excessively. Allow such a battery to “Rest” for several hours (overnight if possible) before determining if it is defective. Be very suspicious of any **36V / 48V** battery that does not have at least **33V / 44 Volts** (OCV) before it is recharged. It may well be seriously damaged and unsafe for any type of use or recharge. The unit’s Battery Condition Indication LED will help you determine if battery is less than **33 Volts / 44 Volts (YELLOW)** or greater than **33 Volts / 44 Volts (GREEN)**

11. After battery has been fully charged, the **GREEN** Charge-Float LED Indicator will begin blinking. It will continue to blink indefinitely, unless unit is disconnected from battery. Should battery be unable to be fully charged, the LED will not blink and the **RED** Error LED will blink. Battery may not be able to be fully charged, may be too large or too deeply discharged to be fully charged in the normal time allowed by charger. If you are certain battery is not defective, having read and understood completely all of the above concerns and conditions, proceed to reboot unit by unplugging from A.C. electrical outlet, disconnect from battery so there will be no electrical power going to the unit from either direction, wait 10 seconds, connect to battery only. Make battery selection if needed by pushing **SELECT BATTERY TYPE** button once or twice, then plug into A.C. outlet. This allows charger to begin charging battery again. If battery is not defective it should be able to be fully charged after being restarted. After sufficient time has lapsed the **GREEN** charge LED Indicator will blink confirming when / if battery is now fully charged.
12. After carefully reading these instructions and Troubleshooting (pgs. 21 - 22) sections, should you still have questions, please e-mail our technical support department at: techsupport@vdcelectronics.com.
13. Allow up to 3 business days for a detailed response to your questions. Always identify the model number of the product and revision letter of this manual contained on this page below. Without this information we may not be able to assist you correctly.

Battery Configurations

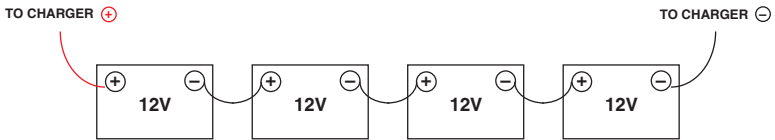
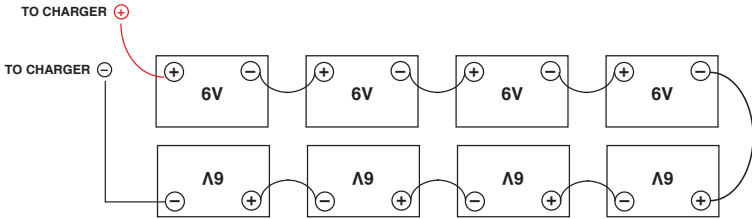
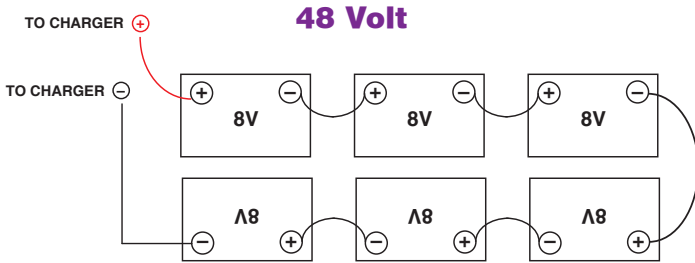
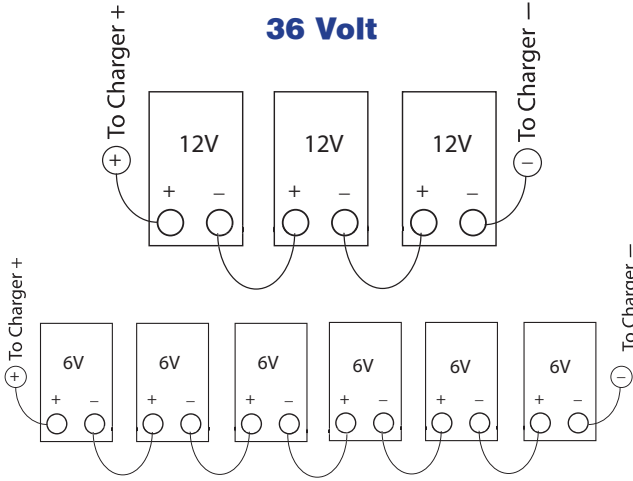

The chart below shows the need to regulate the output voltage of the charger to ensure against over or under charging your battery over a wide range of temperatures.

Temperature Compensated Flooded Battery* Charge and Float Voltages				
	36V		48V	
Temperature	Charge	Float	Charge	Float
> 120°F	41.4	38.4	55.2 V	51.2 V
110°F - 120°F	41.7	38.7	55.6 V	51.6 V
100°F - 110°F	42.0	39.0	56.0 V	52.0 V
90°F - 100°F	42.3	39.3	56.4 V	52.4 V
80°F - 90°F	42.9	39.9	57.2 V	53.2 V
70°F - 80°F	43.2	40.2	57.6 V	53.6 V
60°F - 70°F	43.8	40.8	58.4 V	54.4 V
50°F - 60°F	44.4	41.4	59.2 V	55.2 V
40°F - 50°F	45.0	42.0	60.0 V	56.0 V
< 40°F	45.3	42.3	60.4 V	56.4 V
*AGM Charge & Float: +0.6 V (36271) / +0.8 V (48021) Gel Charge & Float: -0.6 V (36271) / -0.8 V (48021)				

MAINTAINING MULTIPLE BATTERIES

BatteryMINDer **36271** or **48021** Battery Maintainer-Desulfators can be used to **maintain** up to eight batteries at a time, providing each battery is fully operational (no dead-dying cells), free of sulfate and meeting the minimum full charge “rested” (see ***Glossary of Terms***) voltage of 2.13 volts / cell, after being fully desulfated.

ALL batteries Must be properly tested to ensure they are in good condition (no dead-dying cells or excessive sulfation) before maintaining them in multiples. Only healthy, fully desulfated batteries should ever be MAINTAINED in sets of 2 or more. Test each cell of All filler cap batteries using an accurate, temperature compensated hydrometer.

Test sealed (no filler caps) batteries using an accurate, DIGITAL type ONLY, voltmeter. The Minimum voltage Must not be less than 2.13 volts / cell after fully charging battery and letting it “rest” for 12 hours minimum, before testing. If battery voltage is less than 2.13 / cell you must first desulfate it until you reach a “rested” voltage of 2.13 volts / cell.

Attempting to desulfate more than one (1) battery at a time will yield very poor results, as the strongest (healthiest) and not the weakest (most sulfated) battery will receive the majority of the desulfation pulse energy. Exception is when batteries are identical and have been used in parallel or series with each other during their entire life.

TROUBLESHOOTING GUIDE

PROBLEM	POSSIBLE CAUSE	SOLUTION
Power ON indicator does not light after being plugged into AC for 30 seconds.	AC outlet is dead.	Plug in a lamp or other appliance to check for voltage. If controlled by a wall switch, be sure switch is on and try to prevent accidental shut off while charger is working.
ERROR indicator lights RED solid.	Output lead connections to battery may be reversed.	Switch (reverse) connections at battery.
	Battery voltage <9 Volts / 12 Volts.	Battery may be damaged and should not be recharged. Allow battery to “recover” by letting it “rest” without a load.
	Battery was just recently removed from a load (lights, electronic equipment) or not used for extended time without a charger-maintainer.	If battery is healthy and just deeply discharged it should recover its voltage (rise above 6 volts) sufficiently to allow charger to begin an attempt to fully recharge it.
	Battery has “rested” and still cannot be recovered – recharged.	Battery should be safely discarded – recycled.
ERROR Indicator lights RED blinking.	Battery(s) may be weak, heavily sulfated, or too large to fully charge before unit times out.	Allow battery to remain in Maintenance-Float mode for 72 hours or more and then attempt to recharge again.
	Battery may be so large it may require a second full recharge.	Reboot unit by unplugging from A.C. electrical outlet, disconnect from battery so there will be no electrical power going to the unit from either direction, wait 10 seconds, connect to battery first then plug into A.C. outlet
Battery Condition Indicator lights YELLOW (<i>Before</i> battery has been completely charged).	Battery can be weak due to sulfation, self discharge or was very deeply discharged.	Attempt a full recharge and recheck after completion. If still YELLOW , follow next procedure (“After battery has been completely charged.”)

TROUBLESHOOTING GUIDE		
<i>PROBLEM</i>	<i>POSSIBLE CAUSE</i>	<i>SOLUTION</i>
Battery Condition Indicator lights YELLOW (<i>After</i> battery has been completely charged).	Battery still has an unacceptable level of sulfation.	Battery must stay connected to charger and remain in Maintenance-Float mode (GREEN blinking indicator) for 72 hours or longer. Then REBOOT (see below).
ERROR and CHARGE LEDs blink simultaneously	Charger has timed out before battery has completely charged.	Reboot unit by unplugging from A.C. electrical outlet, disconnect from battery so there will be no electrical power going to the unit from either direction, wait 10 seconds, connect to battery first then plug into A.C. outlet.

NOTES

FOR REPAIR OR REPLACEMENT

All returns must be authorized by VDC Electronics.

In the event that you believe your product may be defective, you **MUST** speak to a VDC Electronics technician at **1-800-379-5579 x6 (ET)** before proceeding further. If you must return the unit, the technician will give you an RMA #. Please use Return Form <http://batteryinders.com/forms/returns.pdf> when returning your product.

NOTES

IMPORTANT NOTICE

BatteryMINDer® Five-Year Warranty Registration Reminder
Online Registration:

<http://www.batteryminders.com/register>

Please register your unit online within 10 days of purchase. **Due to the ever-changing technology associated with this BatteryMINDer® unit, we may be unable to keep you apprised of significant upgrades, changes, etc. without your registration.** The information you provide upon registration will be used to keep a record of your purchase and will assist in providing support should you ever need to contact our Technical Service department:
techsupport@vdcelectronics.com; 800-379-5579 x6 (ET).

Model **BatteryMINDer** [36271](#) or [48021](#)

Serial Number _____

Place of purchase _____

Date of purchase _____

RMA# _____

BatteryMINDer® Guarantee and Warranty Policy effective Jan. 2013.

ALL Returns and Replacements must be authorized by a VDC Electronics technician. Units must only be returned to VDC Electronics, Inc., NOT TO THE DEALER FROM WHOM IT WAS PURCHASED.

One-Year 100% Unconditional Money Back Guarantee:

Your BatteryMINDer product is guaranteed within the first year to perform as claimed or VDC Electronics, Inc. will refund your full purchase price including all taxes, shipping or handling cost applicable to the purchase. Customer will return product to VDC Electronics at their expense.

Please call 800-379-5579 x6, M - F, 9 AM - 5 PM (ET) to speak to a technician and have your unit available when you call. This information is required:

- Your contact information
- Product serial number
- Proof of purchase

The Technician will provide you with an RMA number and shipping information. Please be sure to write this down. You will be required to fill out this form to complete your return: <http://batteryminders.com/forms/returns.pdf>. Clearly write your RMA number on the outside of the package you are returning. We suggest using a carrier that provides tracking information. VDC Electronics is not responsible for packages lost in transit to VDC Electronics. If the unit is to be replaced, it is shipped by ground with free shipping. Expedited shipping is available at extra cost.

Five-Year Limited Warranty:

Your BatteryMINDer product is warrantied for FIVE years from date of purchase at retail against defective material or workmanship. We make no warranty other than this limited warranty and expressly exclude any implied warranty including any warranty for consequential damages. This limited warranty is not transferable.

- If the technician determines defective unit should be **repaired**, customer will return product at their expense. Once we receive the unit it will be repaired and shipped back to customer, all at no charge. Expedited shipping is available at extra cost.
- If the technician determines unit does not need repair but only needs **replacement**, customer will be required to pay a \$9.95 shipping fee for the replacement unit. This fee may be subject to change without notice. There is no cost for the replacement unit itself. Expedited shipping is available at extra cost.

Please call 800-379-5579 x6 M - F, 9 AM - 5 PM (ET) to speak to a technician and have your unit available when you call. The technician will do troubleshooting to see if the product is defective. If it is, then this information is required:

- Your contact information
- Product serial number
- Proof of purchase

The Technician will provide you with an RMA number and shipping information. Please be sure to write this down. You will be required to fill out this form to complete your return: <http://batteryminders.com/forms/returns.pdf>. Clearly write your RMA number on the outside of the package you are returning. We suggest using a carrier that provides tracking information. VDC Electronics is not responsible for packages lost in transit to VDC Electronics.