

COTEK

SK Series

Pure Sine Wave Inverter

User's Manual

Table of Contents

1. Important Safety Information.....	1
1-1 General Safety Precautions.....	1
1-2 Battery Precautions.....	1
2. Features.....	2
2-1 Application.....	2
2-2 Electrical Performance.....	3~7
2-3 Mechanical Drawings.....	8~9
3. Introduction.....	10
3-1 Front Panel operation.....	10~13
3-2 Rear Panel operation.....	14~15
3-3 Protections Features.....	15
3-4 Installation.....	16
3-5 Making DC Wiring Connections	17~19
3-6 AC Safety Grounding.....	20
3-7 Inverter Operation.....	21
4. Troubleshooting guide.....	22
5. Maintenance.....	23
6. Warranty.....	23

1. Important Safety Instructions



WARNING!

Before using the Inverter, read and save the safety instructions.

1-1. General Safety Precautions

- 1-1-1. Do not expose the Inverter to rain, snow, spray, bilge or dust. To reduce risk of hazard, do not cover or obstruct the ventilation openings. Do not install the Inverter in a zero-clearance compartment. Overheating may result.
- 1-1-2. To avoid a risk of fire and electronic shock, make sure that existing wiring is in good electrical condition and not undersized. Do not operate the Inverter with damaged or substandard Wiring.
- 1-1-3. There are some components in the inverter can cause arcs and sparks. To prevent from fire or explosion, do not put batteries, flammable materials, or anything should be ignition-protected around the inverter.

1-2. Precautions When Working with Batteries

- 1-2-1. If battery acid contacts skin or clothing, you shall wash it out with soap and water immediately. If battery acid contacts your eyes, you shall wash it out with cold running water for at least 20 minutes and get medical attention immediately.
- 1-2-2. Never smoke or make a spark or flame in the vicinity of the battery or the engine.
- 1-2-3. Do not drop a metal tool on the battery. The resulting spark or short-circuit on the battery of other electrical part may cause an explosion.
- 1-2-4. Remove personal metal items such as rings, bracelets, necklaces, and watches when operating with a lead-acid batteries. Doing so may cause short circuit and very high temperature, which can melt metal items and even burn you.

2-2. Electrical Performance

Specification	Model No.					
Item	SK700-112	SK700-124	SK700-148	SK700-212	SK700-224	SK700-248
Continuous Output Power	700W					
Maximum Output Power	770W					
Surge Rating (Max.)	1400W					
Input voltage	12V	24V	48V	12V	24V	48V
Output Voltage	100 / 110 / 120V +/- 5%			220 / 230 / 240V +/- 3%		
Frequency (Switch Selections)	50 / 60Hz +/- 0.05%					
Output Waveform	Pure Sine Wave (THD < 3%)					
Efficiency (full load) Max. *1	89.0%	91.0%	92.0%	91.0%	93.0%	94.0%
No Load Current Draw (Max.)	1.25A	0.64A	0.31A	1.20A	0.60A	0.28A
Stand-By Current Draw (Max.)	0.25A	0.15A	0.08A	0.25A	0.15A	0.08A
Input Voltage Regulation	10.5-15 VDC	21.0-30 VDC	42-60 VDC	10.5-15 VDC	21.0-30 VDC	42-60 VDC
Input Level Indicator	Red / Orange / Green LED					
Load Level Indicator						
Failure Indicator	Red LED					
Protection	Overload, Short Circuit, Reverse Polarity (Fuse), Over / Under Input Voltage, Over Temperature.					
Remote Control Unit	CR-6 / CR-8 Optional					
Safety Cert.	Meet UL458			EN60950-1		
EMC	FCC Class A			EN55022: 1997 EN55024: 1997 EN61000-3-2: 1998 EN61000-3-3: 1995		e-mark e13 022986
Operating Temperature Range	0 - 40 °C					
Storage Temperature Range	-30°C to 70°C					
Cooling	Loading controlled cooling fan					
Dimensions	273(L)*179(W)*71.5(H)mm / 10.75(L)*7.05(W)*2.81(H) Inch					
Weight	2.7kg / 5.4 Lbs.					

Note: The specifications are subject to change without notice.

Specification	Model No.					
Item	SK1000-112	SK1000-124	SK1000-148	SK1000-212	SK1000-224	SK1000-248
Continuous Output Power	1000W					
Maximum Output Power	1100W					
Surge Rating (Max)	2000W					
Input voltage	12V	24V	48V	12V	24V	48V
Output Voltage	100 / 110 / 120V +/- 5%			220 / 230 / 240V +/- 3%		
Frequency (Switch Selectable)	50 / 60Hz +/- 0.05%					
Output Waveform	Pure Sine Wave (THD < 3%)					
Efficiency (full load) Max. *1	89.0%	92.0%	93.0%	91.0%	94.0%	95.0%
No Load Current Draw (Max.)	1.43A	0.75A	0.38A	1.25A	0.65A	0.35A
Stand-By Current Draw (Max.)	0.25A	0.15A	0.09A	0.25A	0.15A	0.09A
Input Voltage Regulation	10.5-15 VDC	21.0-30 VDC	42-60 VDC	10.5-15 VDC	21.0-30 VDC	42-60 VDC
Input Level Indicator	Red / Orange / Green LED					
Load Level Indicator						
Failure Indicator	Red LED					
Protection	Overload, Short Circuit, Reverse Polarity (Fuse), Over / Under Input Voltage, Over Temperature.					
Remote Control Unit	CR-6 / CR-8 Optional					
Safety Certification	UL458			EN60950-1		
EMC	FCC Class A			EN55022: 1997 EN55024: 1997 EN61000-3-2: 1998 EN61000-3-3: 1995		e-mark e13 022694
Operating Temperature Range	0 - 40 °C					
Storage Temperature Range	-30°C to 70°C					
Cooling	Loading controlled cooling fan					
Dimensions	340(L)*182(W)*88(H)mm / 13.39(L)*7.17(W)*3.46(H) Inch					
Weight	4 kg / 8.8 Lbs.					

Note: The specifications are subject to change without notice.

Specification	Model No.					
Item	SK1500-112	SK1500-124	SK1500-148	SK1500-212	SK1500-224	SK1500-248
Continuous Output Power	1500W					
Maximum Output Power	1650W					
Surge Rating (Max)	3000W					
Input voltage	12V	24V	48V	12V	24V	48V
Output Voltage	100 / 110 / 120V +/- 5%			220 / 230 / 240V +/- 3%		
Frequency (Switch Selectable)	50 / 60Hz +/- 0.05%					
Output Waveform	Pure Sine Wave (THD < 3%)					
Efficiency (full load) Max. *1	88.0%	91.0%	92.0%	90.0%	93.0%	94.0%
No Load Current Draw (Max)	1.45A	0.75A	0.40A	1.40A	0.70A	0.40A
Stand-By Current Draw (Max)	0.28A	0.15A	0.09A	0.28A	0.15A	0.09A
Input Voltage Regulation	10.5-15 VDC	21.0-30 VDC	42-60 VDC	10.5-15 VDC	21.0-30 VDC	42-60 VDC
Input Level Indicator	Red / Orange / Green LED					
Load Level Indicator						
Failure Indicator	Red LED					
Protection	Overload, Short Circuit, Reverse Polarity (Fuse), Over / Under Input Voltage, Over Temperature.					
Remote Control Unit	CR-6 / CR-8 Optional					
Safety Certification	Meet UL458			EN60950-1		
EMC	FCC Class A			EN55022: 1997 EN55024: 1997 EN61000-3-2: 1998 EN61000-3-3: 1995		e-mark e13 22876
Operating Temperature Range	0 - 40 °C					
Storage Temperature Range	-30°C to 70°C					
Cooling	Loading controlled cooling fan					
Dimensions	370(L)*191(W)*88(H)mm / 14.57(L)*7.52(W)*3.46(H) Inch					
Weight	4.8 kg / 10.56 Lbs.					

Note: The specifications are subject to change without notice.

Specification	Model No.					
Item	SK2000-112	SK2000-124	SK2000-148	SK2000-212	SK2000-224	SK2000-248
Continuous Output Power	2000W					
Maximum Output Power	2200W					
Surge Rating (Max)	4000W					
Input voltage	12V	24V	48V	12V	24V	48V
Output Voltage	100 / 110 / 120V +/- 5%			220 / 230 / 240V +/- 3%		
Frequency (Switch Selectable)	50 / 60Hz +/- 0.05%					
Output Waveform	Pure Sine Wave (THD < 3%)					
Efficiency (full load) Max. *1	89.0%	92.0%	93.0%	91.0%	94.0%	95.0%
No Load Current Draw (Max)	2.8A	1.5A	0.7A	2.64A	1.32A	0.65A
Stand-By Current Draw (Max)	0.60A	0.30A	0.15A	0.60A	0.25A	0.15A
Input Voltage Regulation	10.5-15 VDC	21.0-30 VDC	42-60 VDC	10.5-15 VDC	21.0-30 VDC	42-60 VDC
Input Level Indicator	Red / Orange / Green LED					
Load Level Indicator						
Failure Indicator	Red LED					
Protection	Overload, Short Circuit, Reverse Polarity (Fuse), Over / Under Input Voltage, Over Temperature.					
Remote Control Unit	CR-6 / CR-8 Optional					
Safety Certification	Meet UL458			EN60950-1		
EMC	FCC Class A			EN55022: 1997 EN55024: 1997 EN61000-3-2: 1998 EN61000-3-3: 1995		e-mark e13 22846
Operating Temperature Range	0 - 40 °C					
Storage Temperature Range	-30°C to 70°C					
Cooling	Loading controlled cooling fan (65°C ON , 45°C OFF)					
Dimensions	368(L)*209(W)*166(H)mm / 14.49(L)*8.23(W)*6.53(H) Inch					
Weight	9 kg / 19.8 Lbs.					

Note: The specifications are subject to change without notice.

Specification	Model No.					
	Item	SK3000-112	SK3000-124	SK3000-148	SK3000-212	SK3000-224
Continuous Output Power	3000W					
Maximum Output Power	3300W					
Surge Rating (Max)	6000W					
Input voltage	12V	24V	48V	12V	24V	48V
Output Voltage	100 / 110 / 120V +/- 5%			220 / 230 / 240V +/- 3%		
Frequency (Switch Selectable)	50 / 60Hz +/- 0.05%					
Output Waveform	Pure Sine Wave (THD < 3%)					
Efficiency (full load) Max. *1	88.0%	91.0%	92.0%	90.0%	93.0%	94.0%
No Load Current Draw (Max)	3.0A	1.6A	0.8A	2.8A	1.5A	0.7A
Stand-By Current Draw (Max)	0.55A	0.35A	0.19A	0.55A	0.35A	0.19A
Input Voltage Regulation	10.5-15 VDC	21.0-30 VDC	42-60 VDC	10.5-15 VDC	21.0-30 VDC	42-60 VDC
Input Level Indicator	Red / Orange / Green LED					
Load Level Indicator						
Failure Indicator	Red LED					
Protection	Overload, Short Circuit, Reverse Polarity (Fuse), Over / Under Input Voltage, Over Temperature.					
Remote Control Unit	CR-6 / CR-8 Optional					
Safety Cert.	Meet UL458			EN60950-1		
EMC	FCC Class A			EN55022: 1997 EN55024: 1997 EN61000-3-2: 1998 EN61000-3-3: 1995		e-mark e13 22845
Operating Temperature Range	0 - 40 °C					
Storage Temperature Range	-30°C to 70°C					
Cooling	Loading controlled cooling fan					
Dimensions	398(L)*209(W)*166(H)mm / 15.67(L)*8.23(W)*6.53(H) Inch					
Weight	9.8 kg / 22 Lbs.					

Note: The specifications are subject to change without notice.

*1 : This test condition is normal DC input (13.5V) and Temperature 25°C.

2-3. Mechanical Drawings

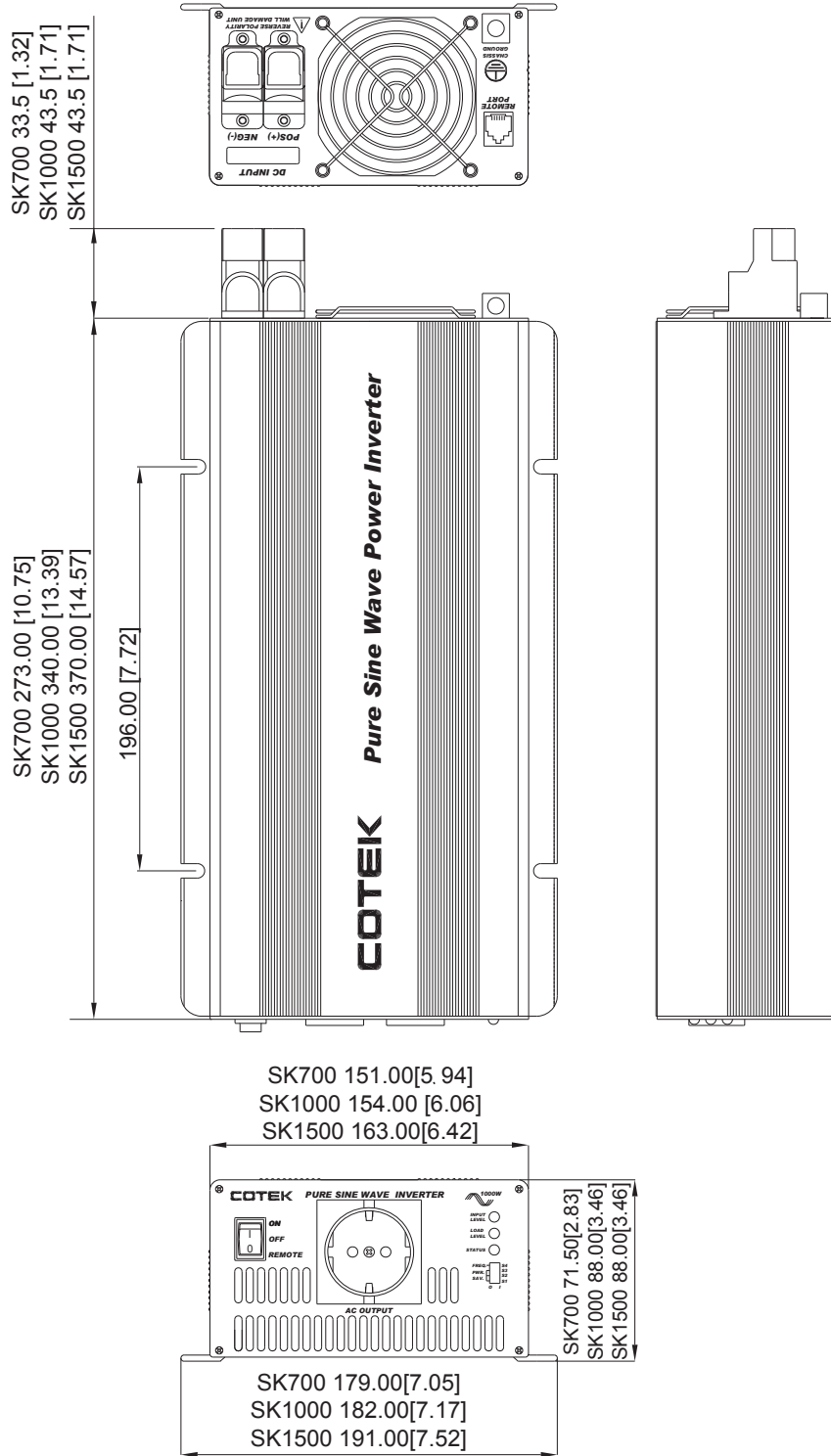

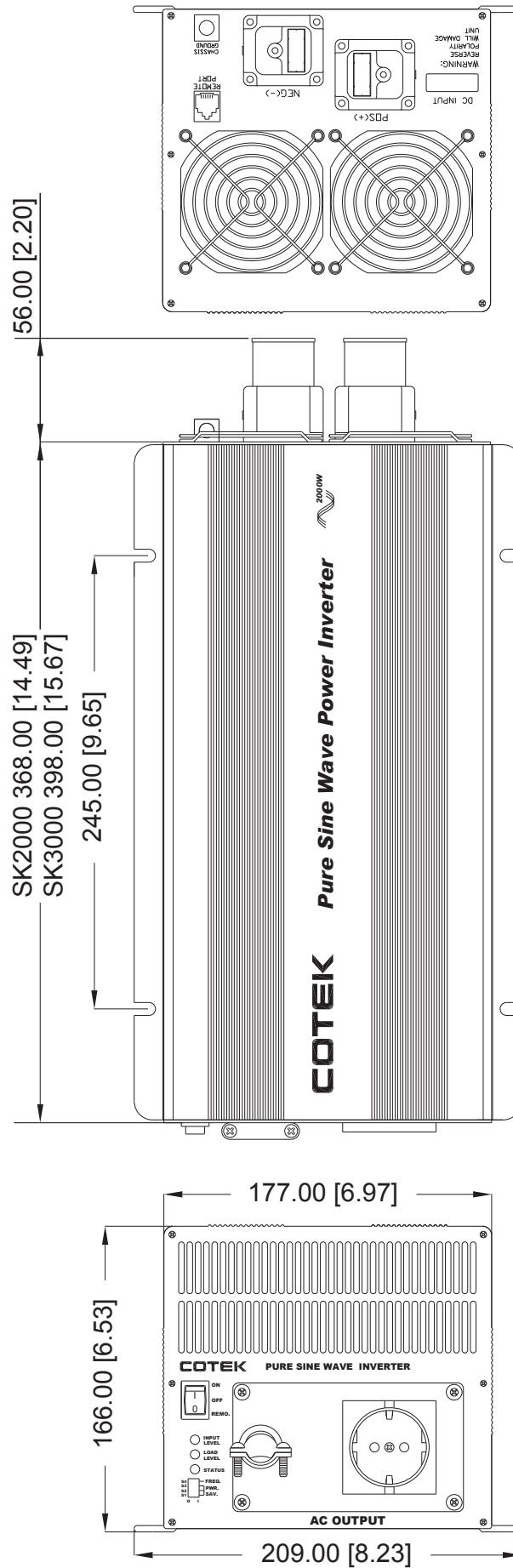

3. Introduction

This power inverter series is one of the most advanced line of mobile AC power systems.

To get the most effective power inverter, it must be installed and used properly. Please read the instructions of this manual before you install and operate this model.

3-1. Front Panel Operations :

3-1-1. Front view :

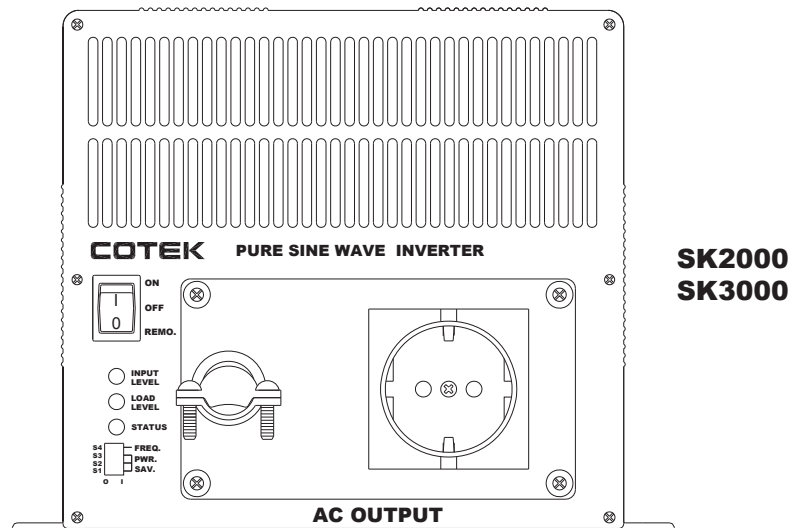
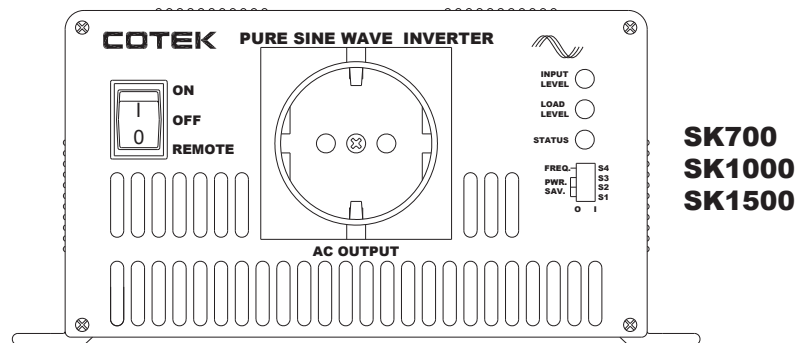

3-1-2. ON / OFF/ REMOTE (Main) switch :

- a. Before installing the inverter, you need to ensure the main switch must be “OFF”.
- b. Before using the remote unit, you need to ensure the main switch must be “ REMOTE”.

3-1-3. Input Level : Display Input Voltages

LED Status	DC 12V	DC 24V	DC 48V
RED Slow Blink	10.3~10.6	20.5~21.2	40.8~42.4
RED	10.6~11.0	21.2~21.8	42.4~43.5
ORANGE	11.0~12.1	21.8~24.1	43.5~48.1
GREEN	12.1~14.2	24.1~28.6	48.1~56.3
ORANGE Blink	14.2~15.0	28.6~30.0	56.3~59.6
OVER RED Blink	15.0↑	30.0↑	59.6↑

3-1-4. Load Level : Display AC Loads (Watts)

LED status	DARK	GREEN	ORANGE	RED	RED BLINK
SK700	0 ~ 56W	56 ~ 230W	230 ~ 525W	525 ~ 672W	Over 672W
SK1000	0 ~ 80W	80 ~ 330W	330 ~ 750W	750 ~ 960W	Over 960W
SK1500	0 ~ 120W	120 ~ 495W	495 ~ 1125W	1125 ~ 1450W	Over 1450W
SK2000	0 ~ 160W	160 ~ 660W	660 ~ 1500W	1500 ~ 1920W	Over 1920W
SK3000	0 ~ 240W	240 ~ 990W	990 ~ 2250W	2250 ~ 2880W	Over 2880W

3-1-5. AC Frequency : Selected by "S4" Dip Switch

Frequency	S4
50 HZ	OFF
60 HZ	ON

3-1-6. Status : Display Power & Fault Status

Green LED	LED Signal	Status
Solid	—————	Power OK
Slow Blink	- - - -	Power Saving
Red LED	LED Signal	Status
Fast Blink	- - - - - - - -	OVP
Slow Blink	- - - -	UVP
Intermittent Blink	OTP
Solid	—————	OLP

3-1-7. Power Saving Mode: Power Saving Mode is adjustable and set by the Dip Switches, S1, S2 and S3 on the front panel.

Example: With the watt setting at 15W, a 15W ↑ load will make the inverter operate normally, a 15W ↓ load will enter into the Power saving mode.

SK700	SK1000 SK1500	SK2000 SK3000	S1	S2	S3
DISABLE	DISABLE	DISABLE	OFF	OFF	OFF
15W	20W	40W	ON	OFF	OFF
25W	40W	80W	OFF	ON	OFF
40W	55W	125W	ON	ON	OFF
50W	75W	170W	OFF	OFF	ON
65W	95W	210W	ON	OFF	ON
75W	115W	245W	OFF	ON	ON
85W	135W	280W	ON	ON	ON

3-1-8. AC outlets (available):

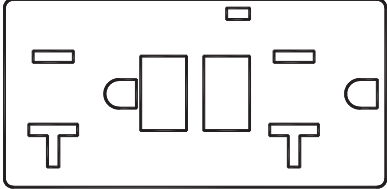
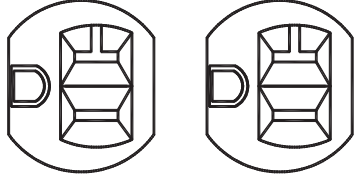
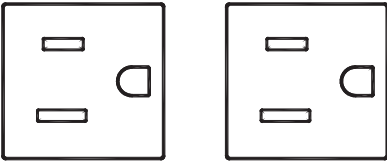
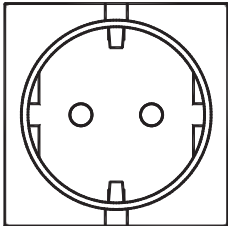
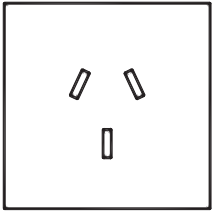
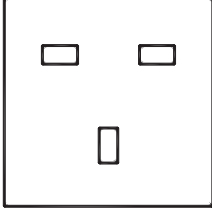
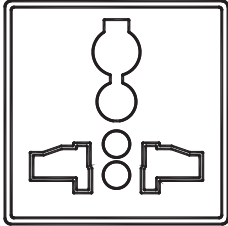
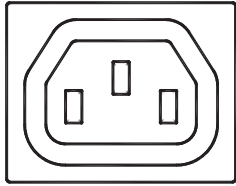
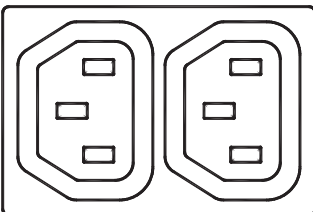
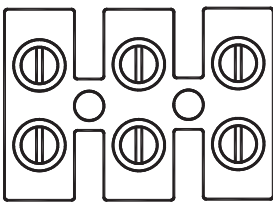
<p>North America (GFCI)</p>	<p>NEMA 5-20R</p>
	
<p>NEMA 5-15R</p>	<p>Continental European</p>
	
<p>Australia / New Zealand</p>	<p>United Kingdom</p>
	
<p>Universal</p>	<p>IEC-1</p>
	
<p>IEC-2</p>	<p>HARD WIRE</p>
	

3-2. Rear Panel Operations :

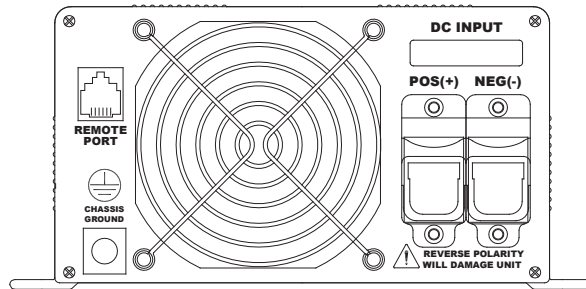

**SK700
SK1000
SK1500**

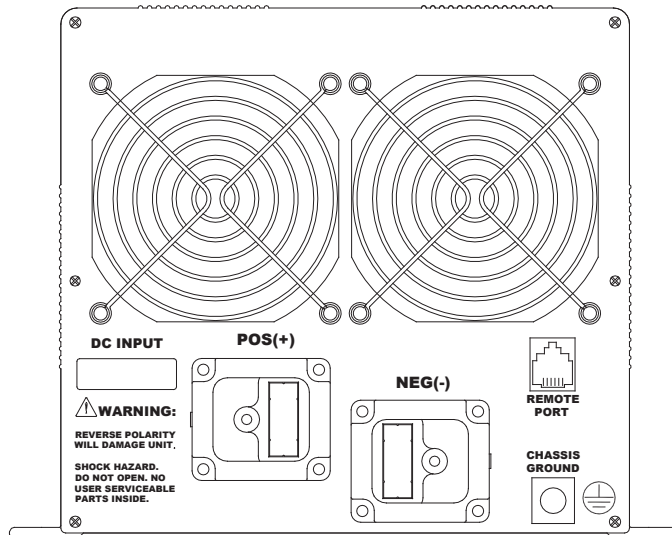

**SK2000
SK3000**

3-2-1. Remote Port:

The SK Series Inverter is compatible with any of the remote controllers, CR-6, CR-7 or CR-8.

Before using the remote unit, you need to ensure the main switch is in the “ REMOTE ” position and the input voltage of the power inverter is the same as it of the remote unit.

3-2-2. Fan Ventilation:

Be sure to keep it a distance (at least 1 inch) form surrounding things.

3-2-3. DC Input Terminal :

Connect DC input terminal to 12V / 24V / 48V battery or the other power sources.

【 + 】 represents positive, and 【 - 】 represents negative. Reverse polarity connection will blow the internal fuse and may damage the inverter permanently.

Model	DC Input Voltage	
	Minimum	Maximum
12 V	10.5	15.0
24 V	21.0	30.0
48 V	42.0	60.0

3-2-4. Use wire # 8 AWG to connect Chassis ground with vehicle chassis.



WARNING!
Operating the inverter without a proper ground Connection may cause an electrical hazard.

3-3. Protections Features:

Model	DC Input (VDC)					Over Temperature Protection			
	Over Voltage		Under Voltage Alarm	Under Voltage		INTERIOR		HEAT SINK	
	Shut-down	Restart		Shut-down	Restart	Shut-down	Restart	Shut-down	Restart
12 V	15.3V	14.3V	11.0V	10.2V	12.7V	70°C	45°C	90°C	60°C
24 V	30.6V	28.6V	22.0V	20.3V	25.2V				
48V	61.0V	57.2V	44.0V	40.8V	49.7V				

3-4. Installation :

The power inverter should be installed in an environment that meets the following requirements :

- 3-4-1. Dry – Do not allow water to drip on or enter into the inverter.
- 3-4-2. Cool – Ambient air temperature should be between 0°C and 40°C, the cooler the better.
- 3-4-3. Safe – Do not install the inverter in a battery compartment or other areas where flammable fumes may exist, such as fuel storage areas or engine compartments.
- 3-4-4. Ventilated –Keep the inverter a distance (as least 1 inch) away from surrounding things. Ensure the ventilation shafts on the rear and the bottom of the unit are not obstructed.
- 3-4-5. Dust – Do not install the Inverter in a dusty environments
The dust can be inhaled into the unit when the cooling fan is working.
- 3-4-6. Close to batteries – Avoid excessive cable lengths. Do not install the Inverter in the same compartment as batteries.
Use the recommended wire lengths and sizes (see section 3-5).
Do not mount the Inverter where it will be exposed to the gases produced by the battery. These gases are very corrosive, and prolonged exposure will damage the Inverter.



WARNING!

Shock Hazard. Before proceeding further, carefully check that the Inverter is NOT connected to any batteries, and that all wiring is disconnected from any electrical sources. Do not connect the output terminals of the Inverter to an incoming AC source.

3-5. DC Wiring Connections :

Follow this procedure to connect the battery cables to the DC input terminals of the Inverter. The cables should be as short as possible (less than 10 feet / 3 meters ideally) and large enough to handle the required current in accordance with the electrical codes or regulations applicable to the installation.

Cables that are not an adequate gauge (too narrow) or too long will deteriorate inverter performance such as poor surge capability and frequent low-input voltage warnings and shutdowns.

These low input voltage warnings are due to DC voltage drop across the cables from the inverter to the batteries.

The longer and narrower the cables, the greater the voltage drop.

Increasing DC cable size helps improve the situation.

COTEK recommends the following cables for optimum inverter performance.

(Apply both 120V and 230V versions)

Model No	Wire AWG	Inline Fuse
SK700-112 / 212	# 4	100 A
SK700-124 / 224	# 6	50 A
SK700-148 / 248	# 8	30 A
SK1000-112 / 212	# 2	150 A
SK1000-124 / 224	# 4	80 A
SK1000-148 / 248	# 6	40 A
SK1500-112 / 212	# 2	200 A
SK1500-124 / 224	# 4	100 A
SK1500-148 / 248	# 6	50 A
SK2000-112 / 212	# 2/0	250 A
SK2000-124 / 224	# 1/0	125 A
SK2000-148 / 248	# 2	70 A
SK3000-112 / 212	# 4/0	400 A
SK3000-124 / 224	# 2/0	200 A
SK3000-148 / 248	# 1/0	100 A

3-5-1. Connect the cables to the power input terminals on the rear panel of the inverter. The red terminal is represents positive (+) and black terminal represents negative (-). Insert the cables into the terminals and tighten the screw to clamp the wires securely.



WARNING!

Ensure all the DC connections are tight (torque to 9 – 10 ft-lbs, 11.7 – 13 Nm). Loose connections may cause overheat and fire.



WARNING!

The installation of a fuse must be on a positive cable. Failure to place a fuse on “+” cables running between the inverter and battery may cause damage to the inverter and will void warranty.

Also, use only high quality copper wire and keep cable length short, a maximum of 3 - 6 feet.

Battery to inverter cable connection

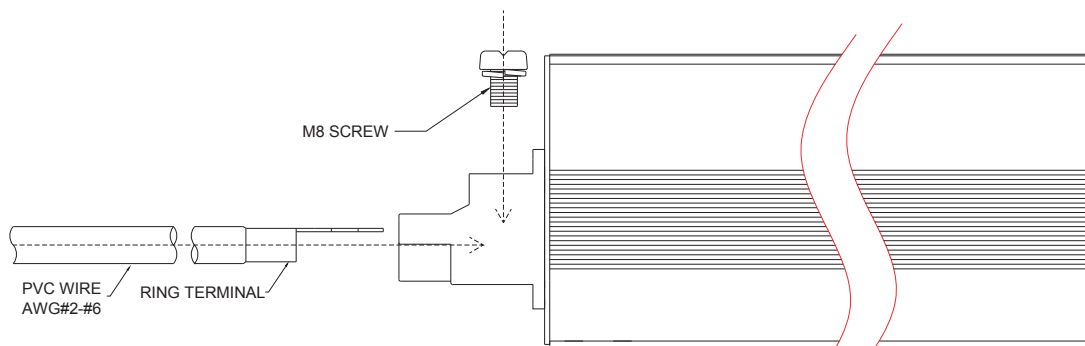

Do not place anything between battery cable lug and terminal surface. Assemble exactly as shown.

**SK700
SK1000
SK1500**

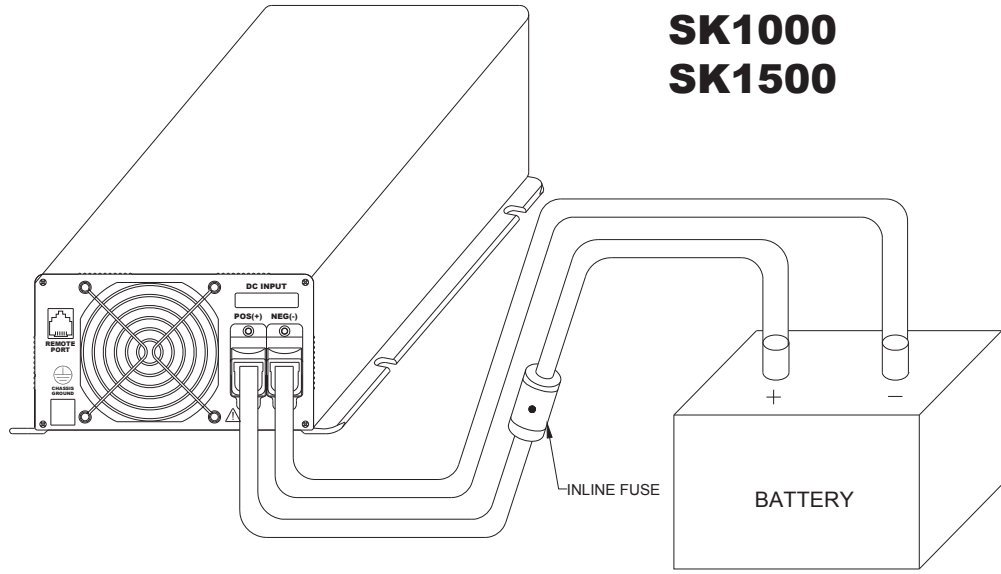

**SK2000
SK3000**

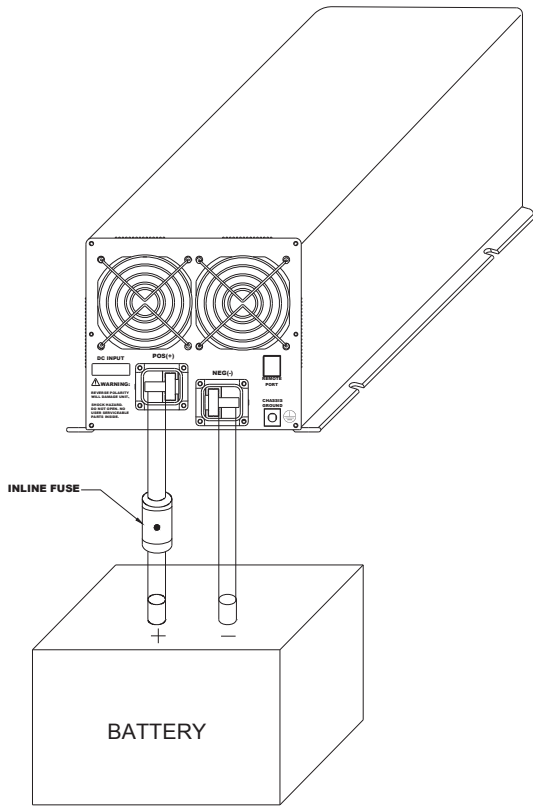

Battery to inverter cable connection

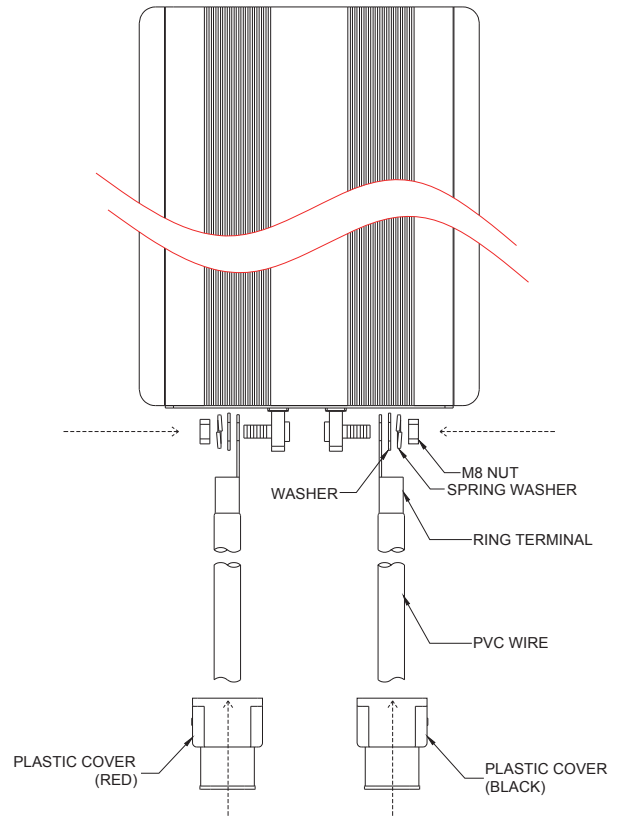

Do not place anything between battery cable lug and terminal surface. Assemble exactly as shown.

3-6. AC Safety Grounding :

The AC output ground wire should go to the grounding point for your loads (for example, a distribution panel ground bus).

3-6-1. Neutral Grounding (GFCI'S) :

3-6-1-1. **120V models** : The neutral conductor of the AC output circuit of the Inverter is automatically connected to the safety ground during inverter operation. This conforms to National Electrical Code requirements that separately derived from AC sources (such as inverters and generators) which have their neutral conductors tied to ground in the same way as the neutral conductors from the utility tied to ground at the AC breaker panel. For models configured with a transfer relay, while AC utility power is present and the Inverter is in bypass mode, this connection (the neutral of the Inverter's AC output to input safety ground) is not present so that the utility neutral is only connected to ground at your breaker panel, as required.

Ground Fault Circuit Interrupters (GFCI) :

Installations in Recreational Vehicles (for North American approvals) will require GFCI protection of all branch circuit connected to the AC output of the hardwire terminal equipped with Inverter. In addition, electrical codes require GFCI protection of certain receptacles in residential installations. While the pure sine wave output of the Inverter is equivalent to the waveform provided by utilities, compliance with UL standards requires us to test and recommend specific GFCI. Cotek has tested the following GFCI – protected 20A receptacles and found that they functioned properly when connected to the output of the Inverter.

3-7. Inverter Operation :

To operate the power inverter, use the ON / OFF switch on the Front panel to turn the power on. Then the power inverter is ready to deliver AC power to your loads. If there is several loads use, turn them on separately after the inverter is "ON" in order to prevent OVP resulted from the surge power.

- 3-7-1. Set the power switch to "ON" position and the buzzer will send out "Beep" sounds at the moment. Then the inverter will make self-diagnosis, and the LED's indicators will also appear various colors. Finally the buzzer will "Beep" again and the Input Level and Status LED indicators will turn to "Green" color, then the inverter starts to work successfully.
- 3-7-2. Set the power switch to the OFF position, then the inverter stops and all the lights go Off.
- 3-7-3. Set the power inverter switch to ON position and turn the test load On. The inverter should supply power to the load. If you plan to accurately measure the true output r.m.s. voltage of the inverter, a meter such as FLUKE 45 BECKMAN 4410 or TRIPLETT 4200 must be used.

4. Troubleshooting :



WARNING!

Do not open or disassemble the Inverter.
 Attempting to service the unit yourself may cause the risk of electrical shock or fire.

Problems and Symptoms	Possible Cause	Solutions
<p>“No AC Power Output”</p> <p>STATUS illuminates the red LED</p>		
a. Blinking fast	Over input voltage. (OVP)	Check input voltage. Reduce input voltage.
b. Blinking slowly.	Low input voltage. (UVP)	Recharge battery. Check connections and the cable.
c. Blinking Intermittently.	Thermal shutdown. (OTP)	Improve ventilation. Make sure ventilation shafts in the inverter are not obstructed. Lower ambient temperature.
d. Solid ON.	Short circuit or Wiring error. Overload.(OLP)	Check AC wiring for short circuit. Reduce the load.

5. Maintenance :

To keep your inverter operating properly, there is very little maintenance required. You should clean the exterior periodically with a damp cloth to prevent accumulation of dust and dirt. At the same time, tighten the screws on the DC input terminals.

6. Warranty :

We guarantee this product against defects in materials and workmanship for a period of 24 months from the date of purchase and will repair or replace any defective power inverters if you directly returned them to us with postage paid.

Please note that Cotek is only responsible for ensuring our products are operational before delivering. This warranty will be considered void if the unit has been misused, altered, or accidentally damaged. Cotek is not liable for anything that occurs as a result of the user's fault.

